

TCM 630/600

TESTATA COMANDO
DRIVING HEAD

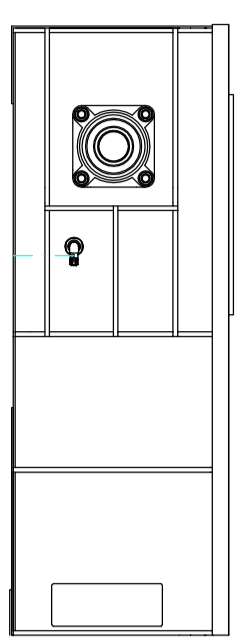

Ø Base TCM630_DPFC_2011

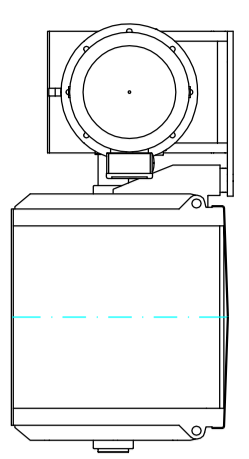

Ø Base TCM630_DPFC_L_2011

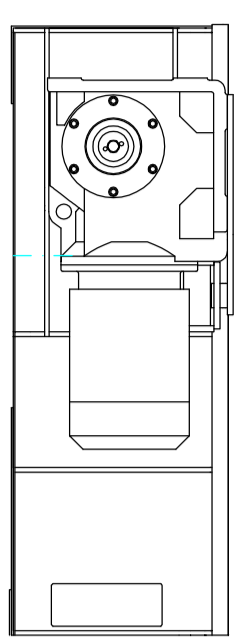

Ø Base TCM630_DPFC_2011

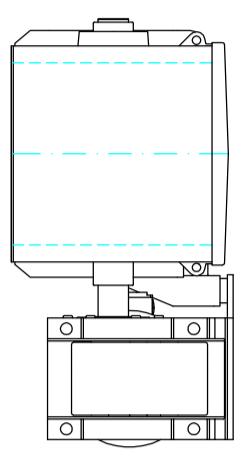

Ø Base TCM630_DPFC_2011

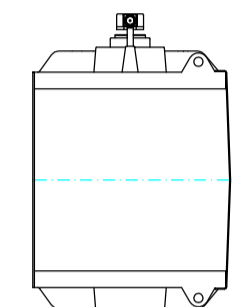

Ø Base TCM630_DPFC_2011

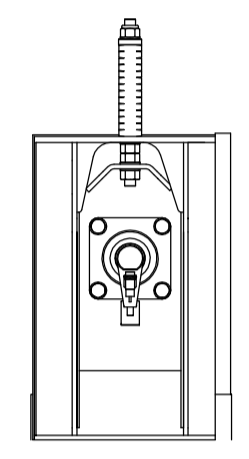

Ø Base TCM630_DPFC_2011

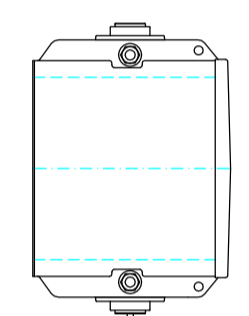

Ø Base TCM630_DPFC_2011

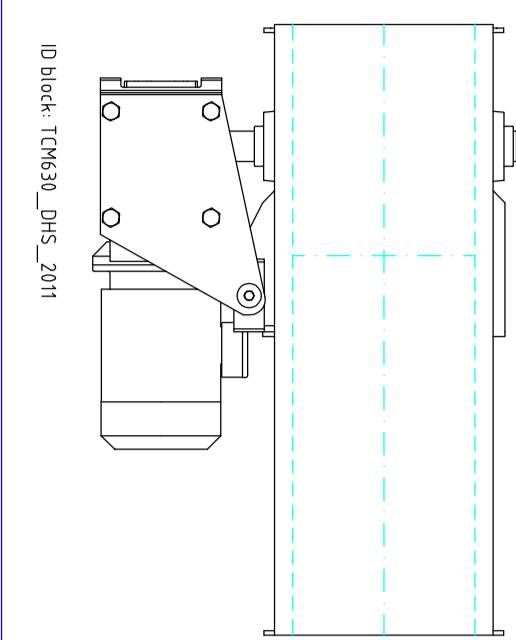

Ø Base TCM630_DPFC_2011

WEIGHTS

PESSI	[kW]	[kg]
22	2390	37
37	2560	55
55	2837	110
		371,3

PIEDE
TAIL

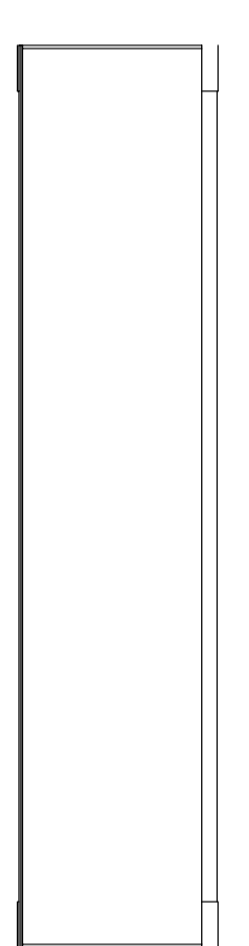

Ø Base TCM630_CSTP_2011

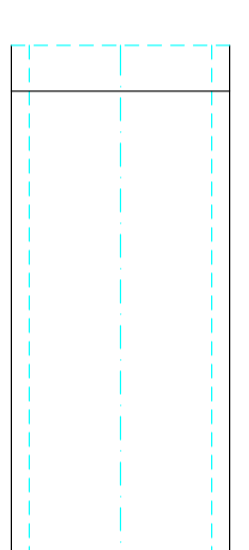

Ø Base TCM630_CSTP_2011

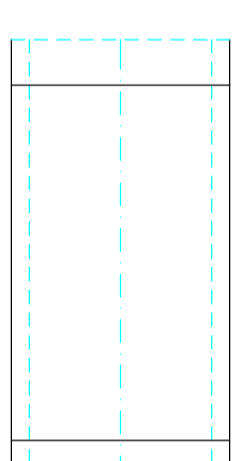

Ø Base TCM630_CSTP_2011



Ø Base TCM630_CSTP_2011

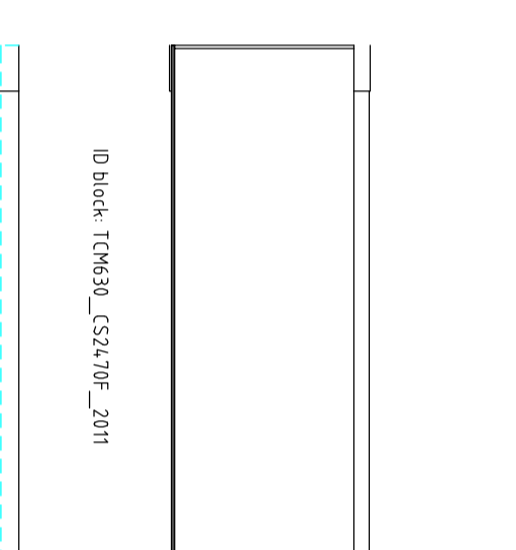

Ø Base TCM630_CSTP_2011

WEIGHTS

PESSI	[kg]
556	

CASSE STANDARD
STANDARD CASINGS

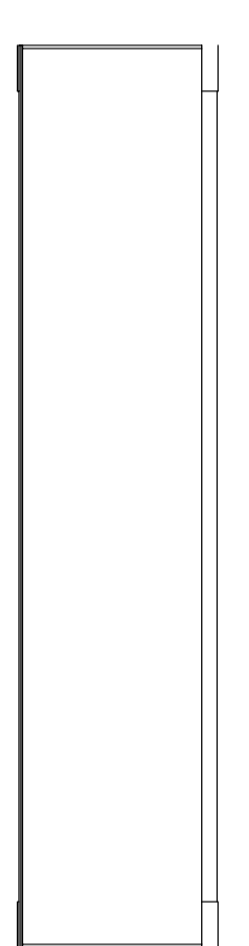

Ø Base TCM630_CSTP_2011

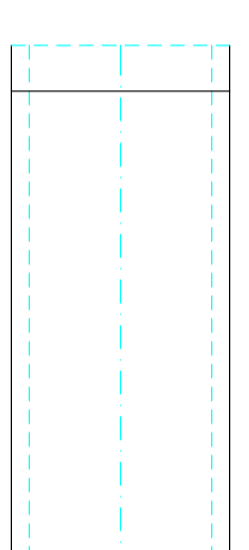

Ø Base TCM630_CSTP_2011

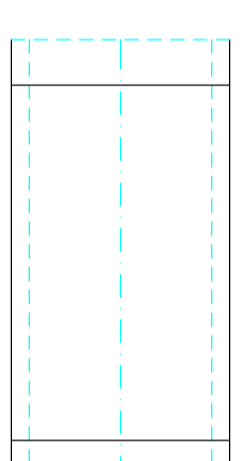

Ø Base TCM630_CSTP_2011



Ø Base TCM630_CSTP_2011

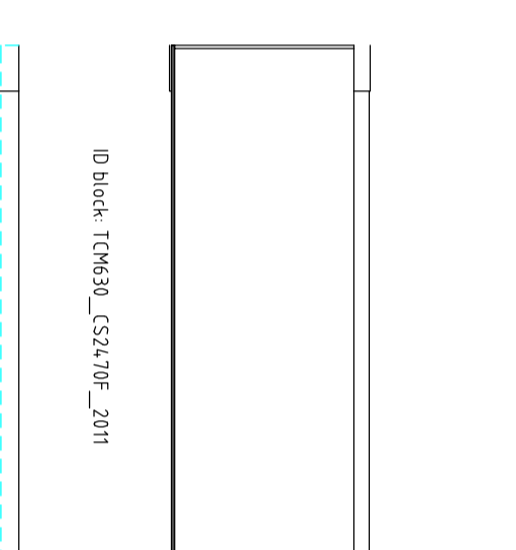

Ø Base TCM630_CSTP_2011

WEIGHTS

PESSI	[kg/m]
4,95	

CASSE ALIMENTAZIONE LATERALE
SIDE INLET CASING

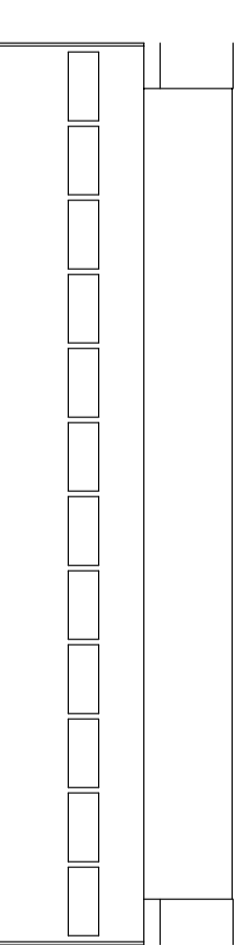

Ø Base TCM630_LICP_2011

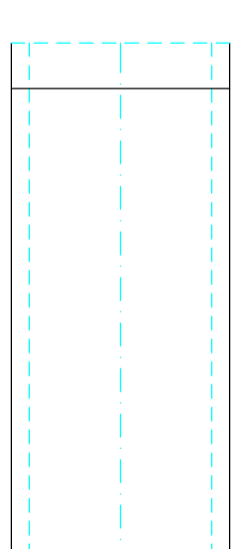

Ø Base TCM630_LICP_2011

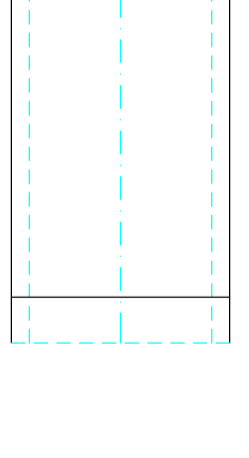

Ø Base TCM630_LICP_2011

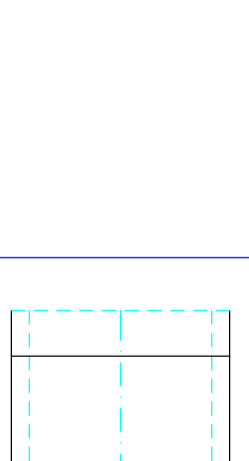

Ø Base TCM630_LICP_2011

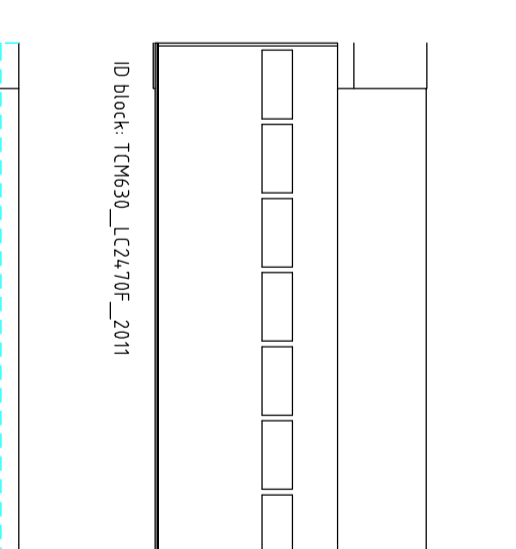

Ø Base TCM630_LICP_2011

WEIGHTS

PESSI	[kg]
556	

CASSA REGOLAZIONE FLUSSO
CASING WITH FLOW REGULATION SYSTEM

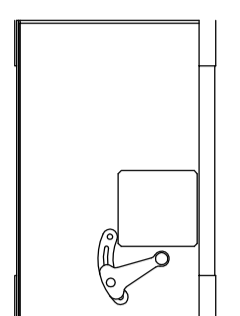

Ø Base TCM630_CRF_2011

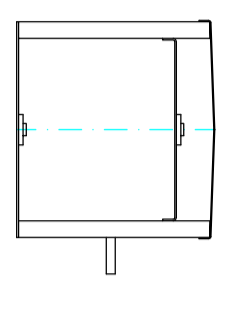

Ø Base TCM630_CRF_2011

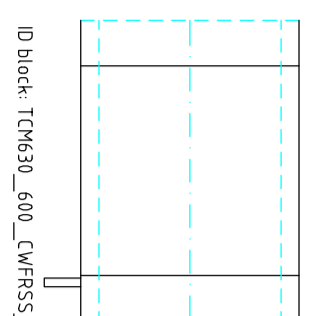

Ø Base TCM630_CRF_2011

SERRANDA LONGITUDINALE A CREMAGLIERA
LONGITUDINAL RACK SLIDE (LRS)

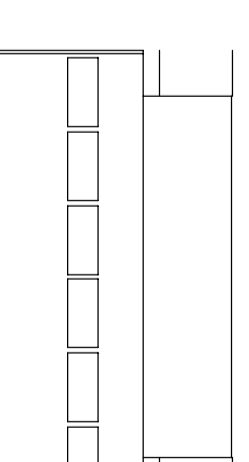

Ø Base TCM630_LCRS_2011

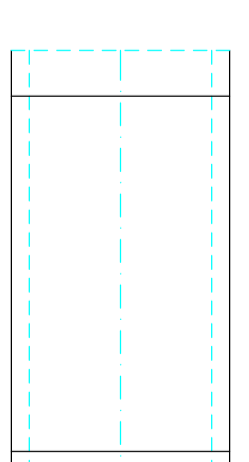

Ø Base TCM630_LCRS_2011



Ø Base TCM630_LCRS_2011



Ø Base TCM630_LCRS_2011

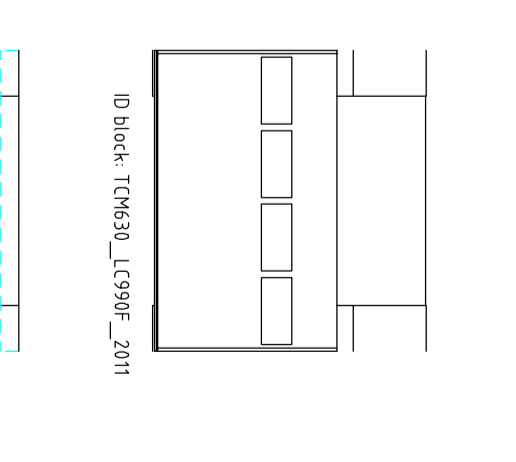

Ø Base TCM630_LCRS_2011

L=990

L=2470

L=990

L=1980

L=1980

L=490

L=1980

L=490

CASSE DOPPIE
DOUBLE CASINGS

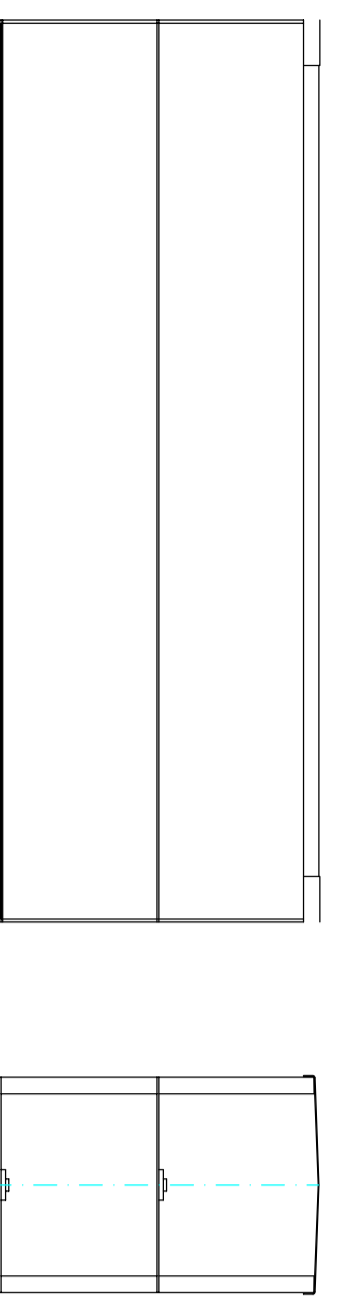

Ø Base TCM630_CDD_2011

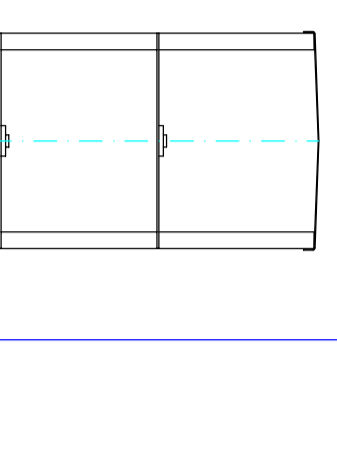

Ø Base TCM630_CDD_2011

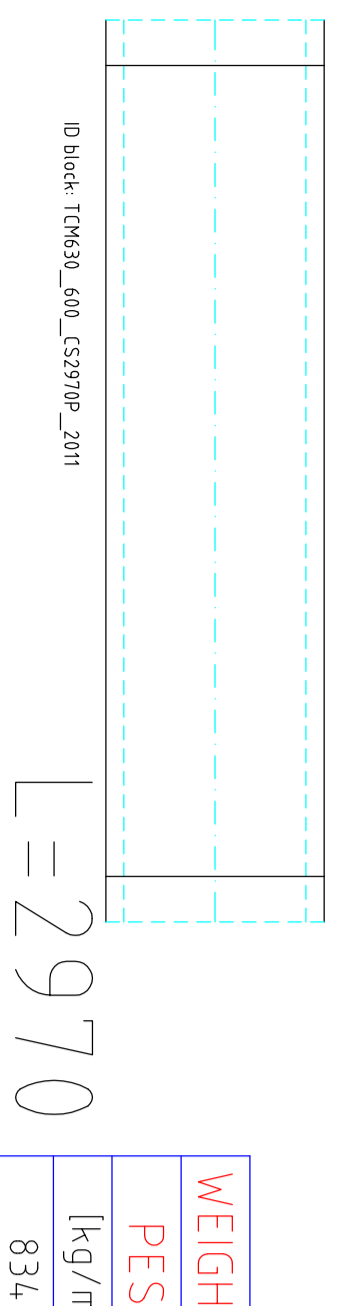

Ø Base TCM630_CDD_2011

L=2970

WEIGHTS

PESSI	[kg/m]
834	

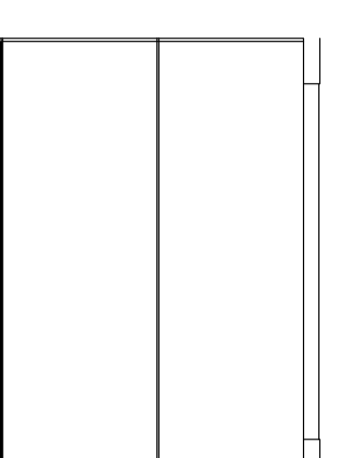

Ø Base TCM630_CDD_2011



Ø Base TCM630_CDD_2011

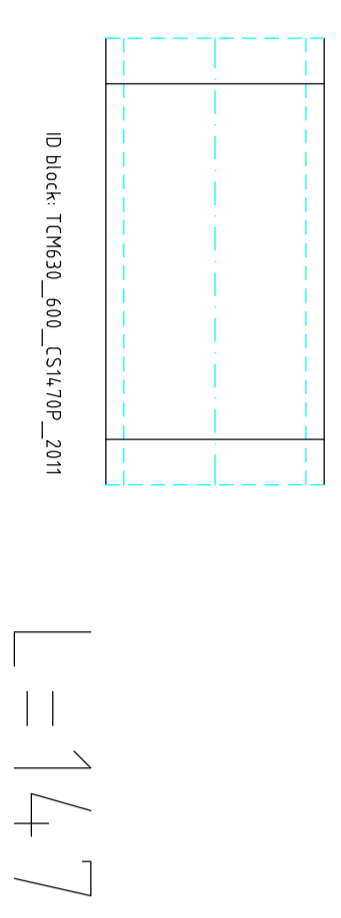

Ø Base TCM630_CDD_2011

L=1470

ACCESSORI
ANCILLARIES

TRAMOGGIA ALIMENTAZIONE
SQUARE INLET HOPPER

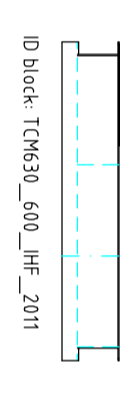

Ø Base TCM630_AIH_2011

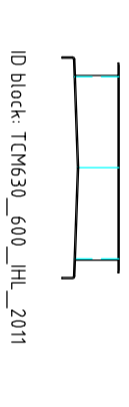

Ø Base TCM630_AIH_2011

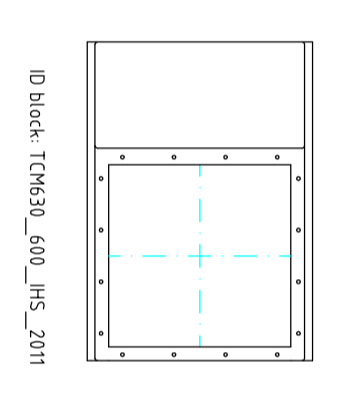

Ø Base TCM630_AIH_2011

SERRANDA LONGITUDINALE A CREMAGLIERA
LONGITUDINAL RACK SLIDE (LRS)



Ø Base TCM630_LCRS_2011



Ø Base TCM630_LCRS_2011

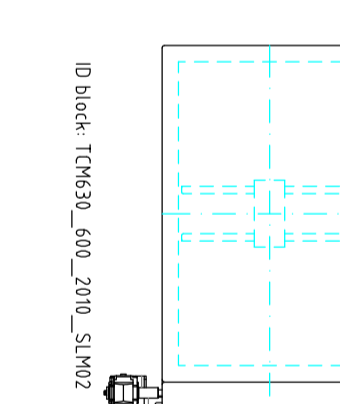

Ø Base TCM630_LCRS_2011

SERRANDA LONGITUDINALE PNEUMATICA
LONGITUDINAL PNEUMATIC SLIDE (LPS)

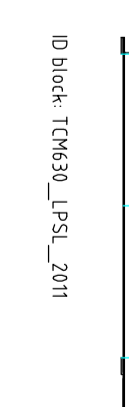

Ø Base TCM630_LPS_2011

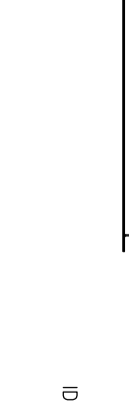

Ø Base TCM630_LPS_2011

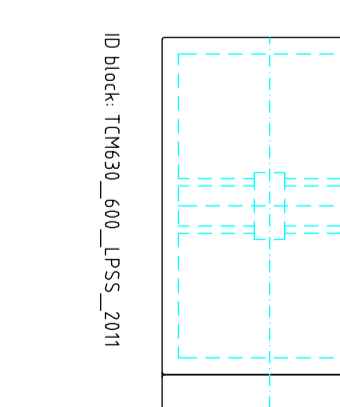

Ø Base TCM630_LPS_2011

TRAMOGGIA SCARICO STANDARD SIMMETRICA
SIMMETRICAL OUTLET HOPPER (SH)

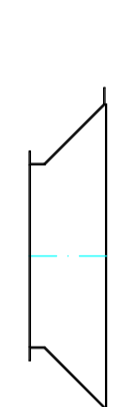

Ø Base TCM630_SSH_2011

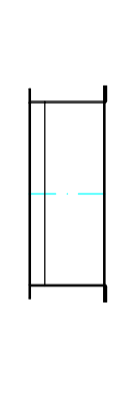

Ø Base TCM630_SSH_2011

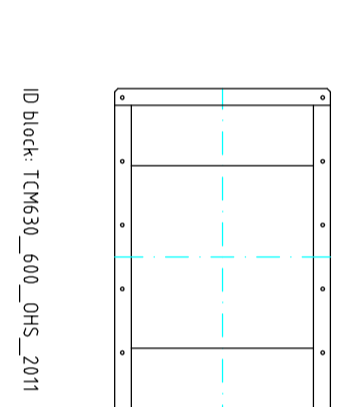

Ø Base TCM630_SSH_2011

SERRANDA TRASVERSALE A CREMAGLIERA
TRANSVERSAL RACK SLIDE (TRS)

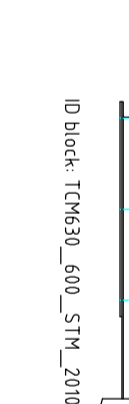

Ø Base TCM630_STR_2011



Ø Base TCM630_STR_2011

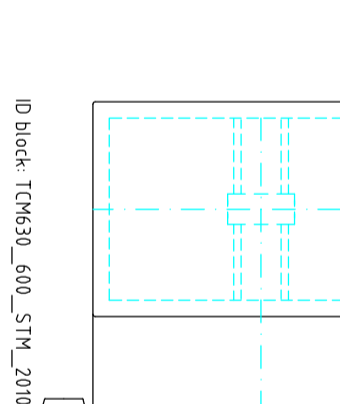

Ø Base TCM630_STR_2011

SERRANDA TRASVERSALE PNEUMATICA
TRANSVERSAL PNEUMATIC SLIDE (TPS)

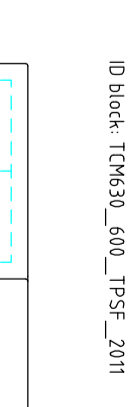

Ø Base TCM630_TPS_2011



Ø Base TCM630_TPS_2011

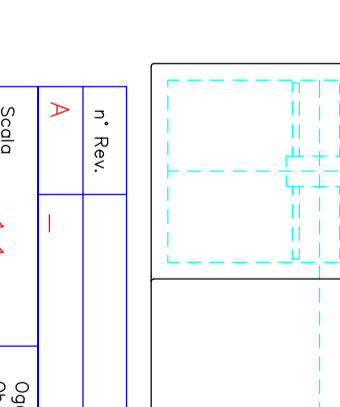

Ø Base TCM630_TPS_2011