

TCM 440/400

TESTATA COMANDO
DRIVING HEAD

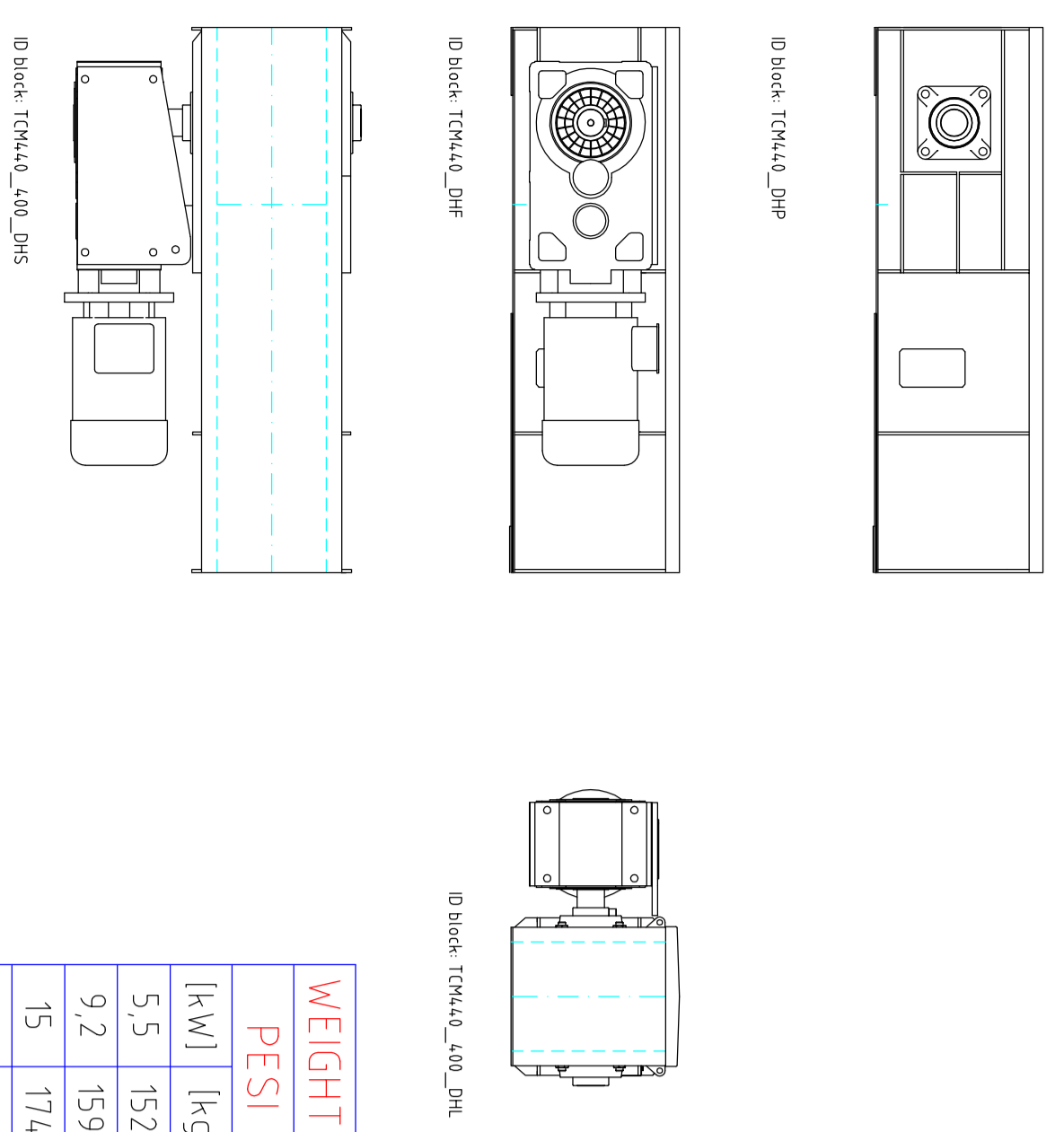

WEIGHTS	
PESI	[kg]
5.5	1525
15	1741
22	1825
37	1995
55	2272

PIEDE
TAIL

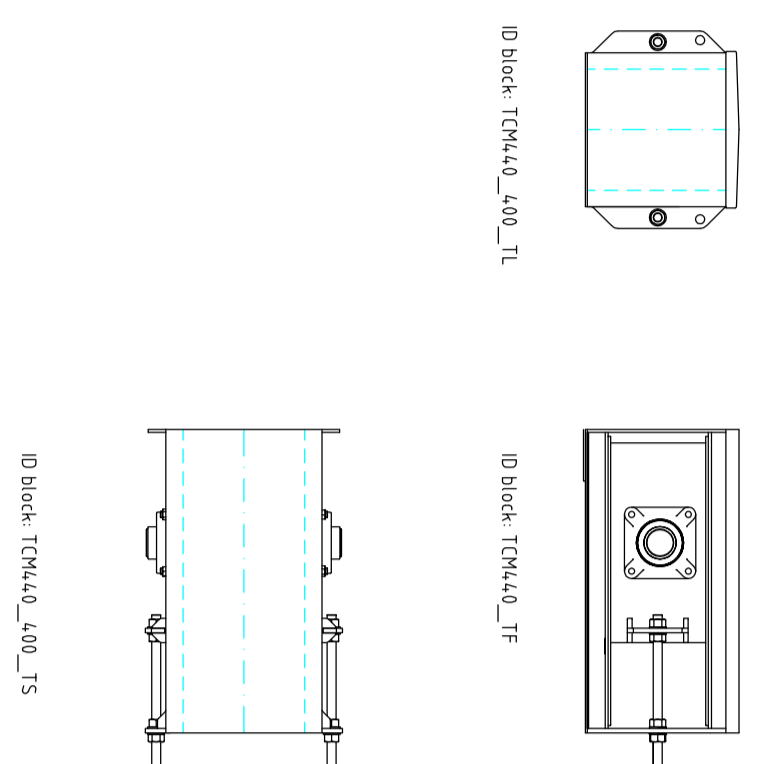

WEIGHTS	
PESI	[kg]
358	

CASSA REGOLAZIONE FLUSSO
CASING WITH FLOW REGULATION SYSTEM

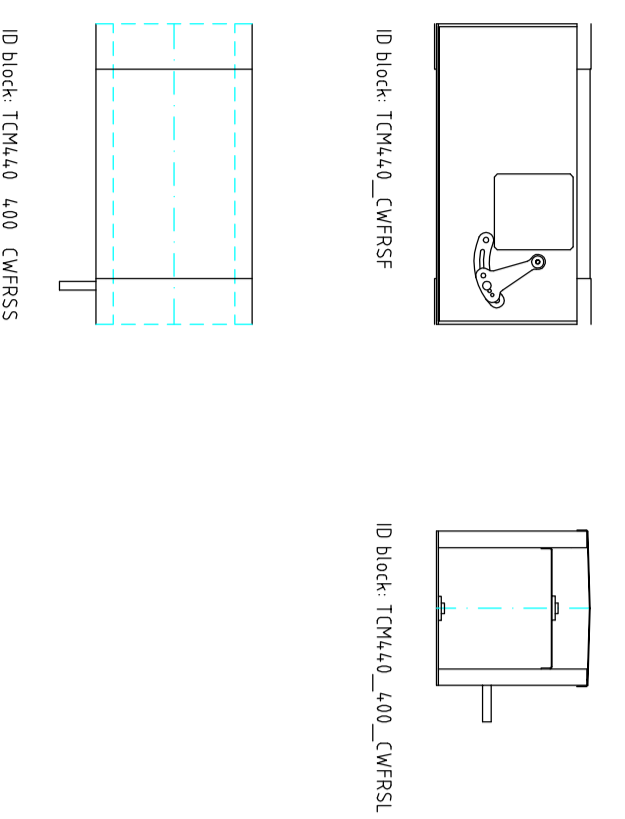

CASSE DOPPIE
DOUBLE CASINGS

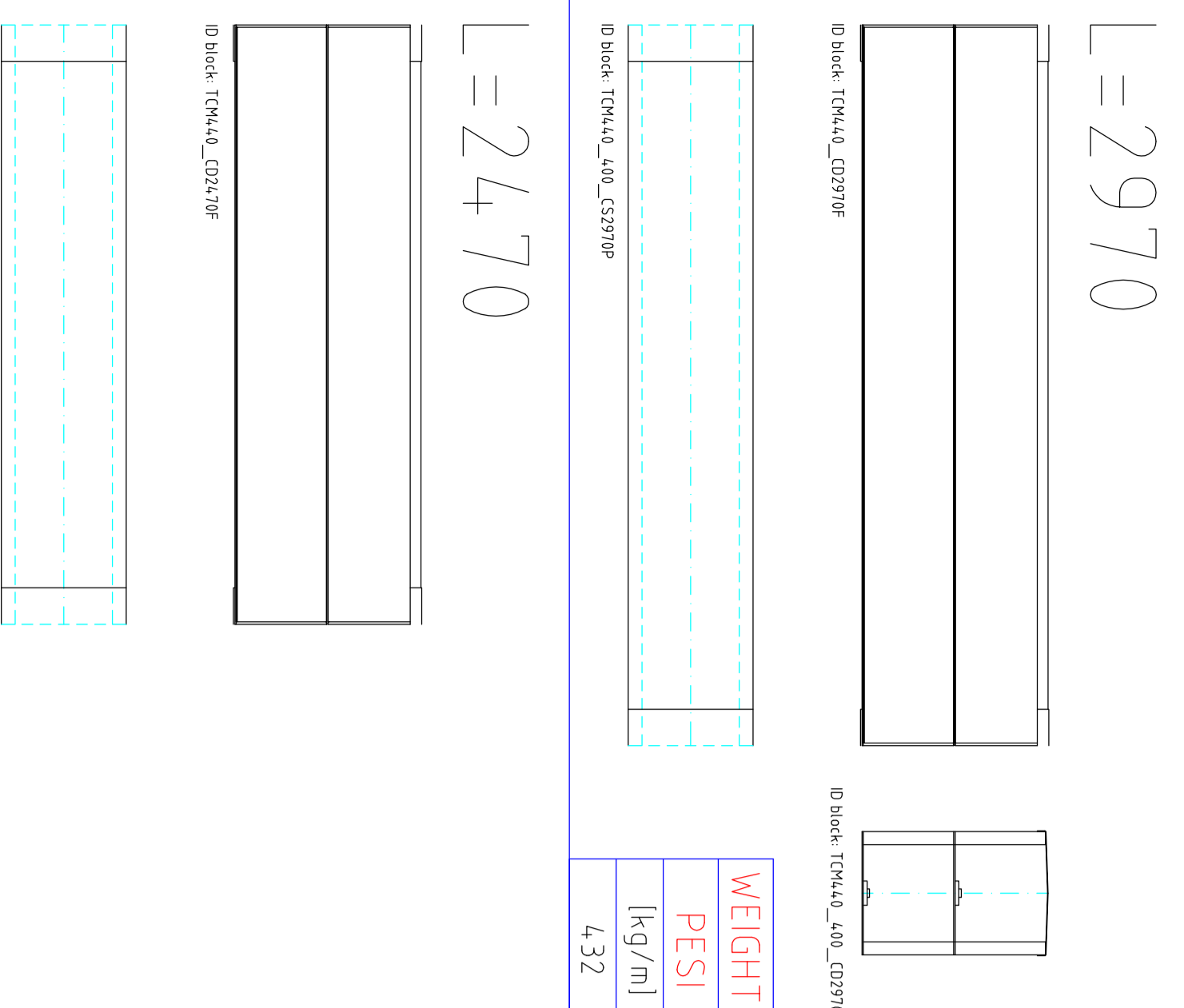

WEIGHTS	
PESI	[kg/m]
4.32	

L=1980

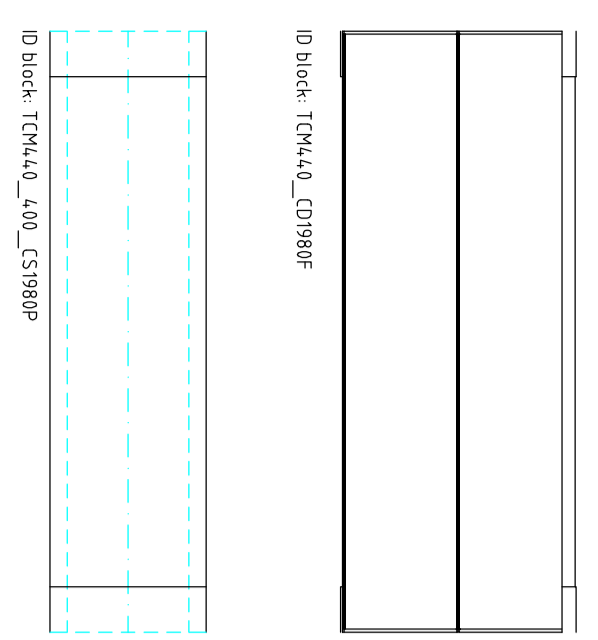

L=490

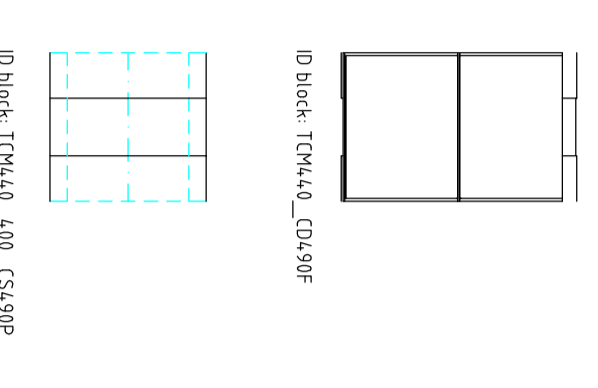

CASSE STANDARD
STANDARD CASINGS

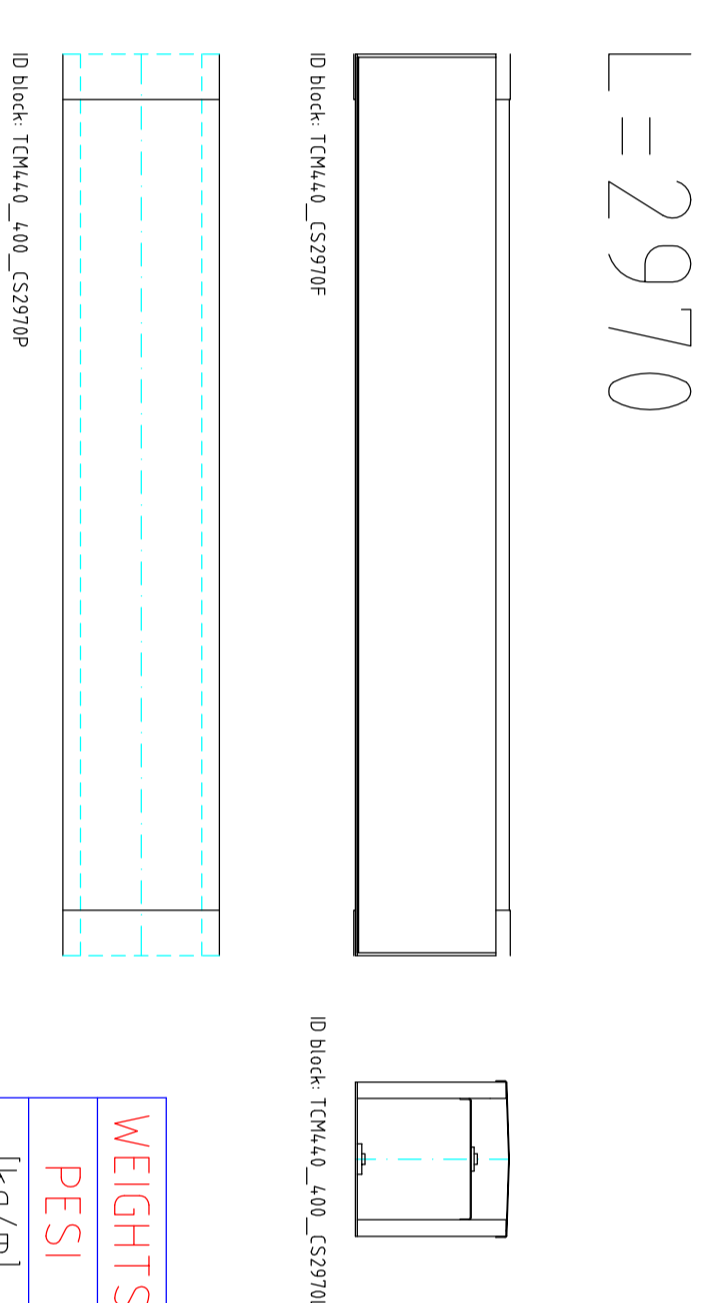

WEIGHTS	
PESI	[kg/m]
266	

L=2470

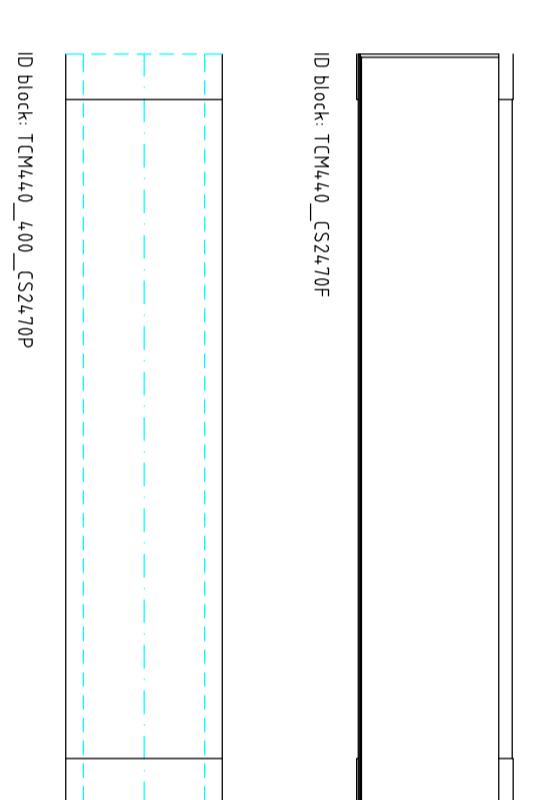

L=1470

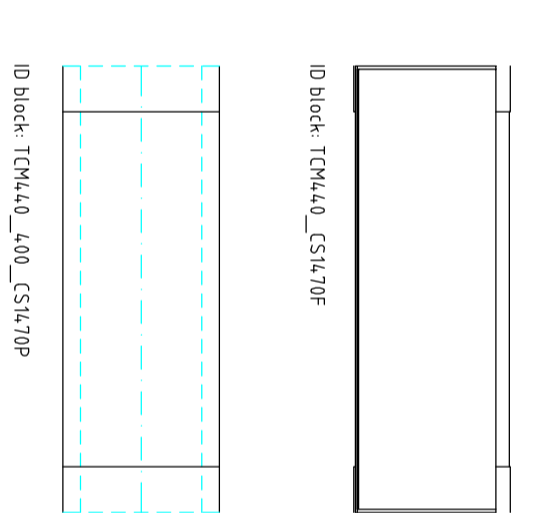

L=990

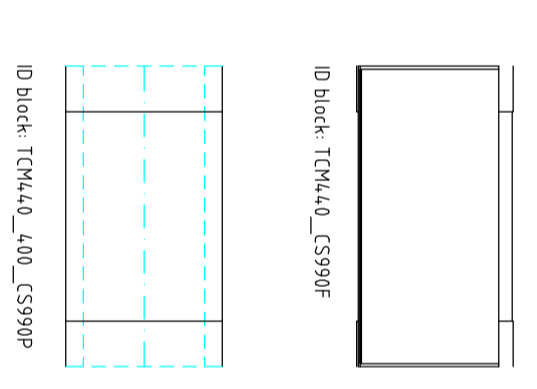

L=1980

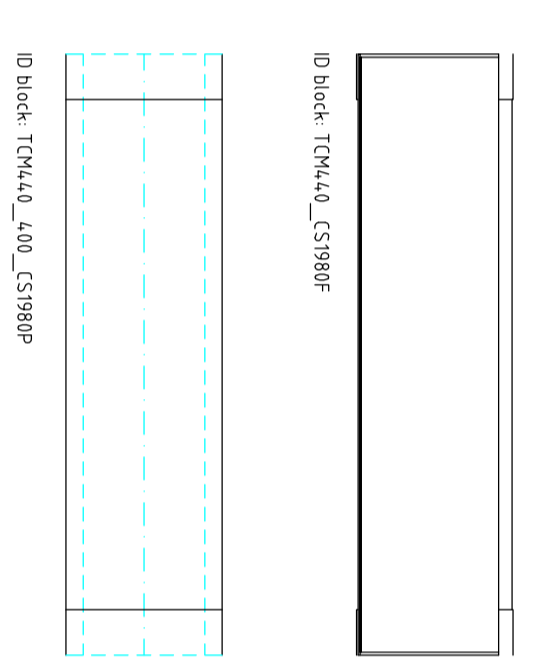

L=490

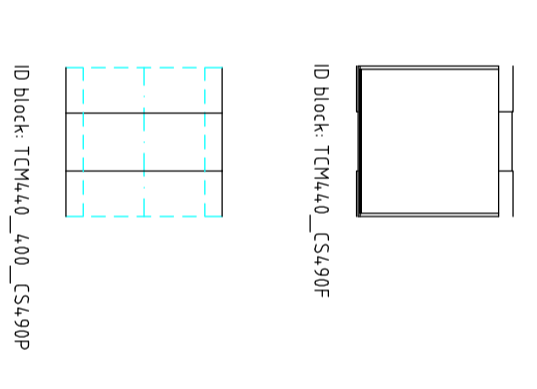

CASSE ALIMENTAZIONE LATERALE
SIDE INLET CASING

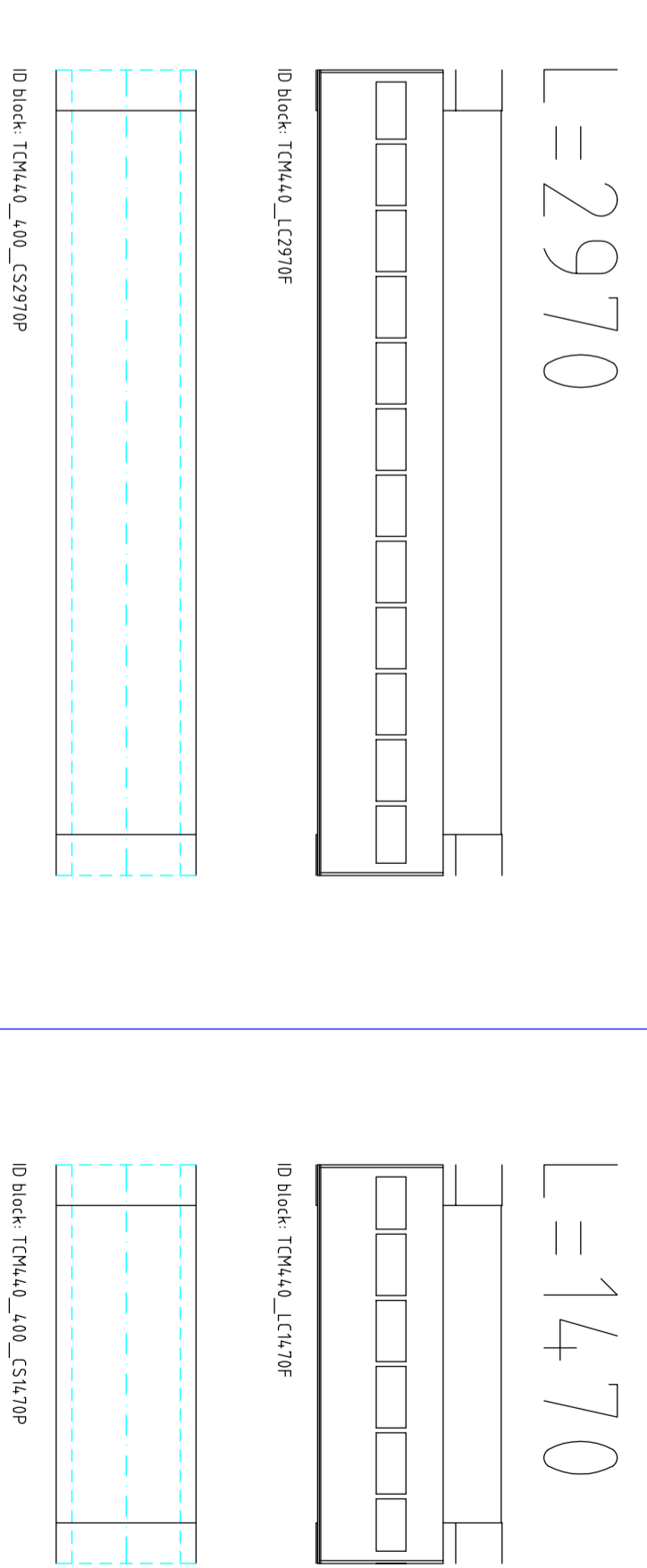

L=1470

L=2470

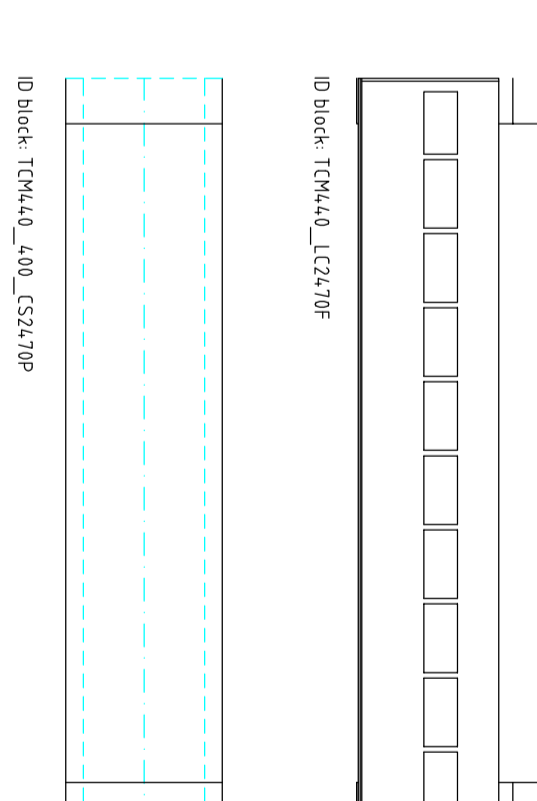

L=990

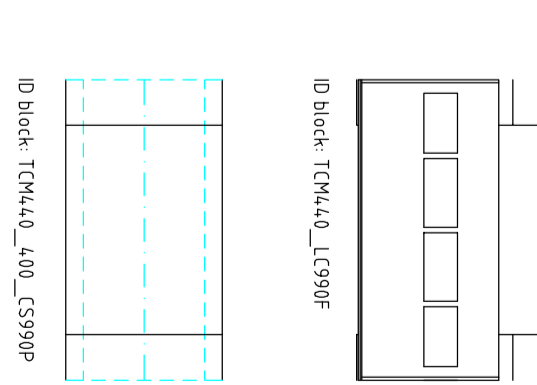

L=1980

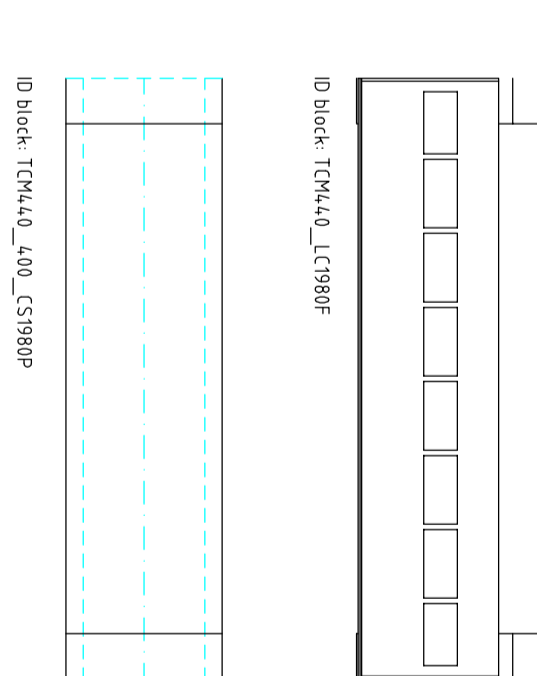

L=490

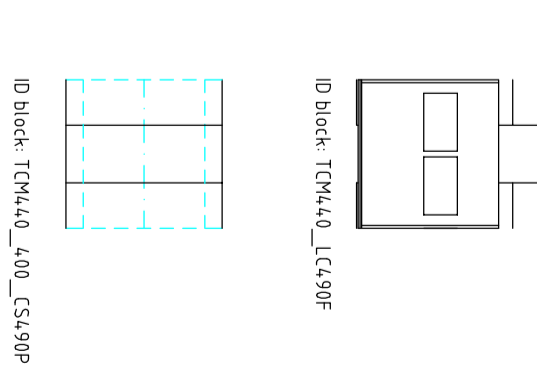

ACCESSORI
ANCILLARIES

TRAMOGGIA ALIMENTAZIONE
SQUARE INLET HOPPER

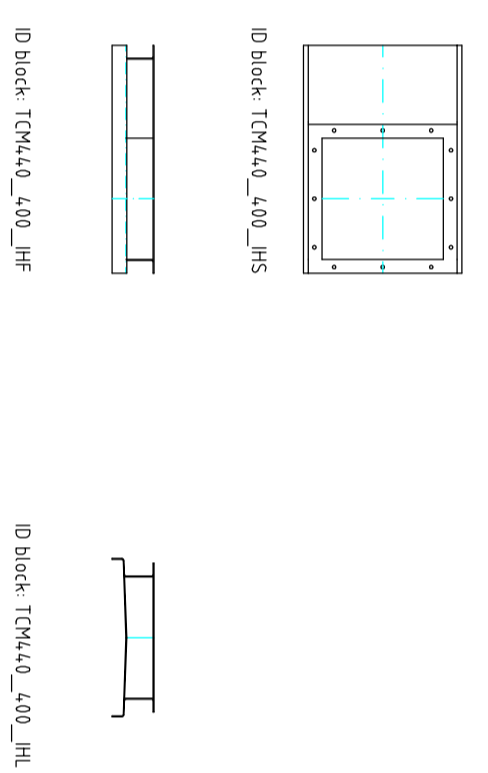

SERRANDA LONGITUDINALE MOTORIZZATA
LONGITUDINAL MOTOR SLIDE (LMS)

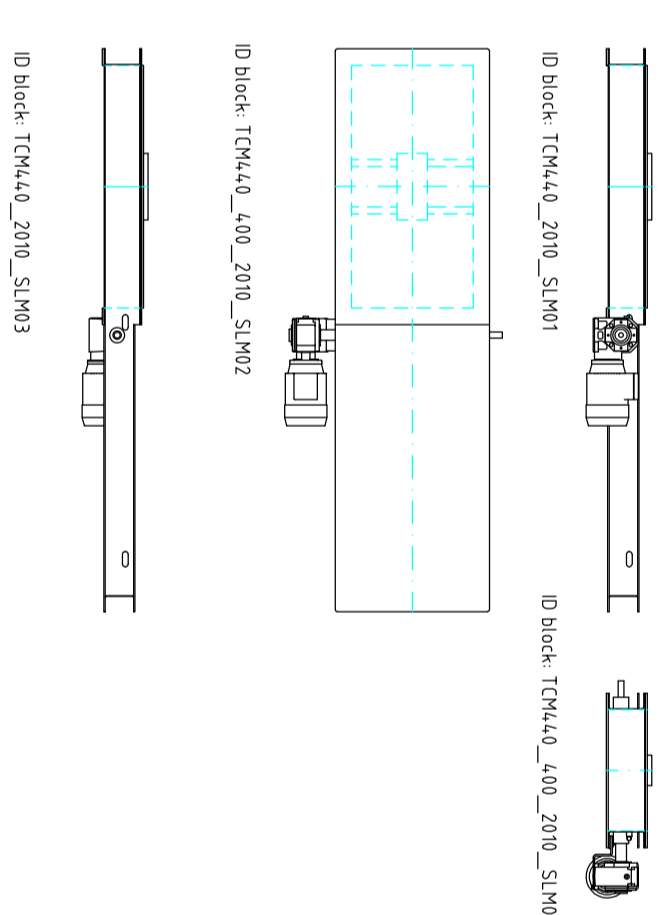

SERRANDA LONGITUDINALE PNEUMATICA
LONGITUDINAL PNEUMATIC SLIDE (LPS)

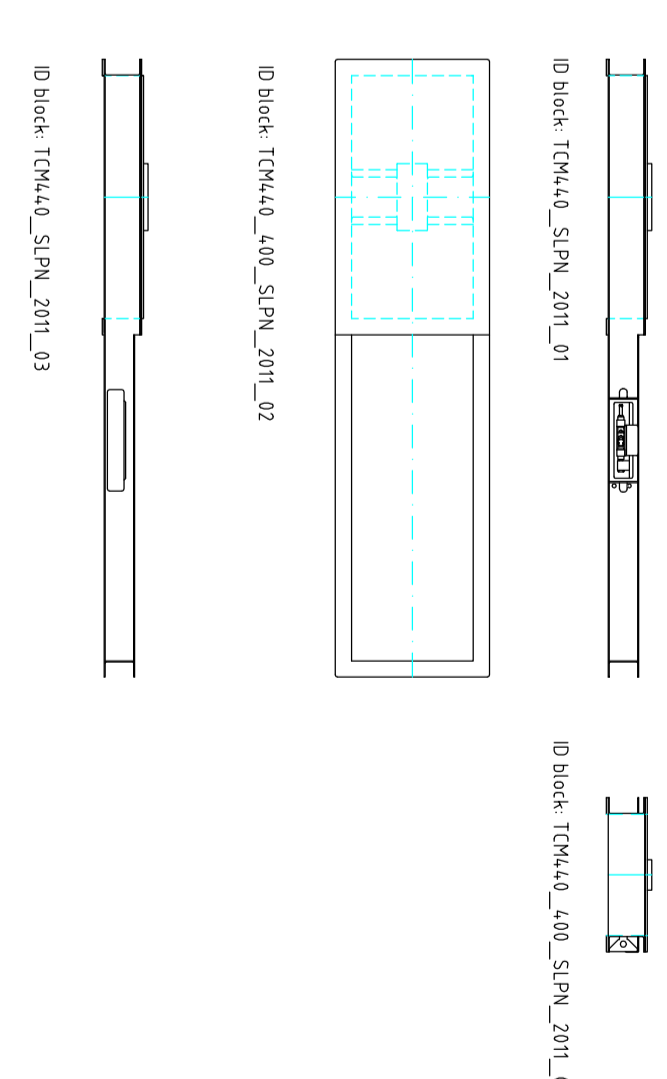

SERRANDA LONGITUDINALE MANUALE
LONGITUDINAL MANUAL SLIDE (LMS)

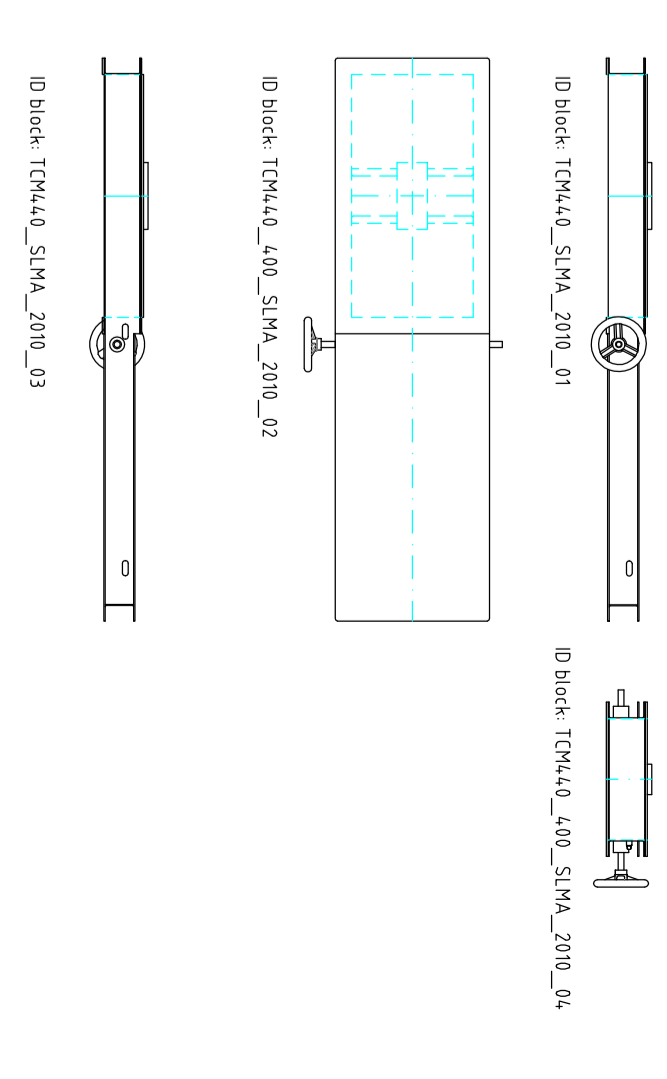

TRAMOGGIA SCARICO
OUTLET HOPPER (SH)

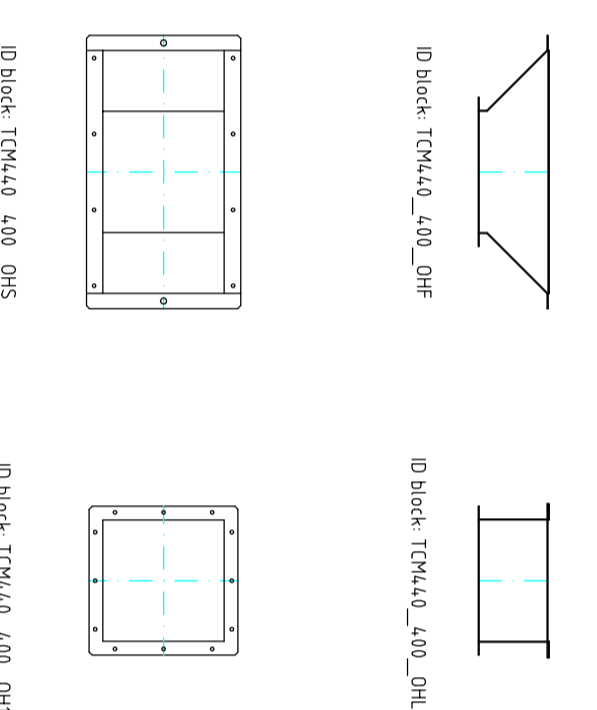

SERRANDA TRASVERSALE MOTORIZZATA
TRANSVERSAL MOTOR SLIDE (TMS)

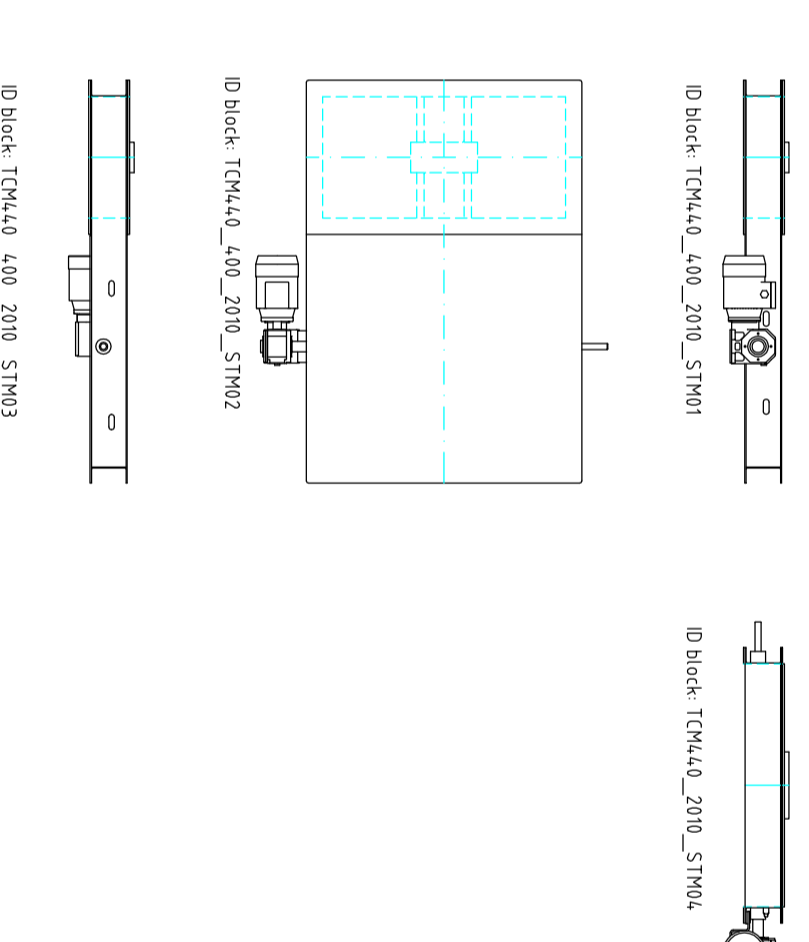

SERRANDA TRASVERSALE PNEUMATICA
TRANSVERSAL PNEUMATIC SLIDE (TMS)

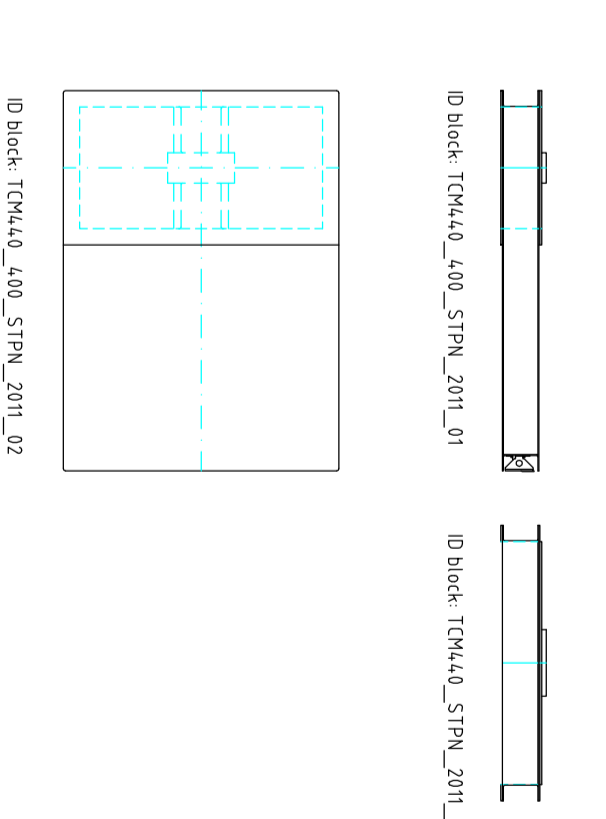

SERRANDA TRASVERSALE MANUALE
TRANSVERSAL MANUAL SLIDE (TMS)

