

# ETM 1200

## TESTATA DI COMANDO DRIVING HEAD

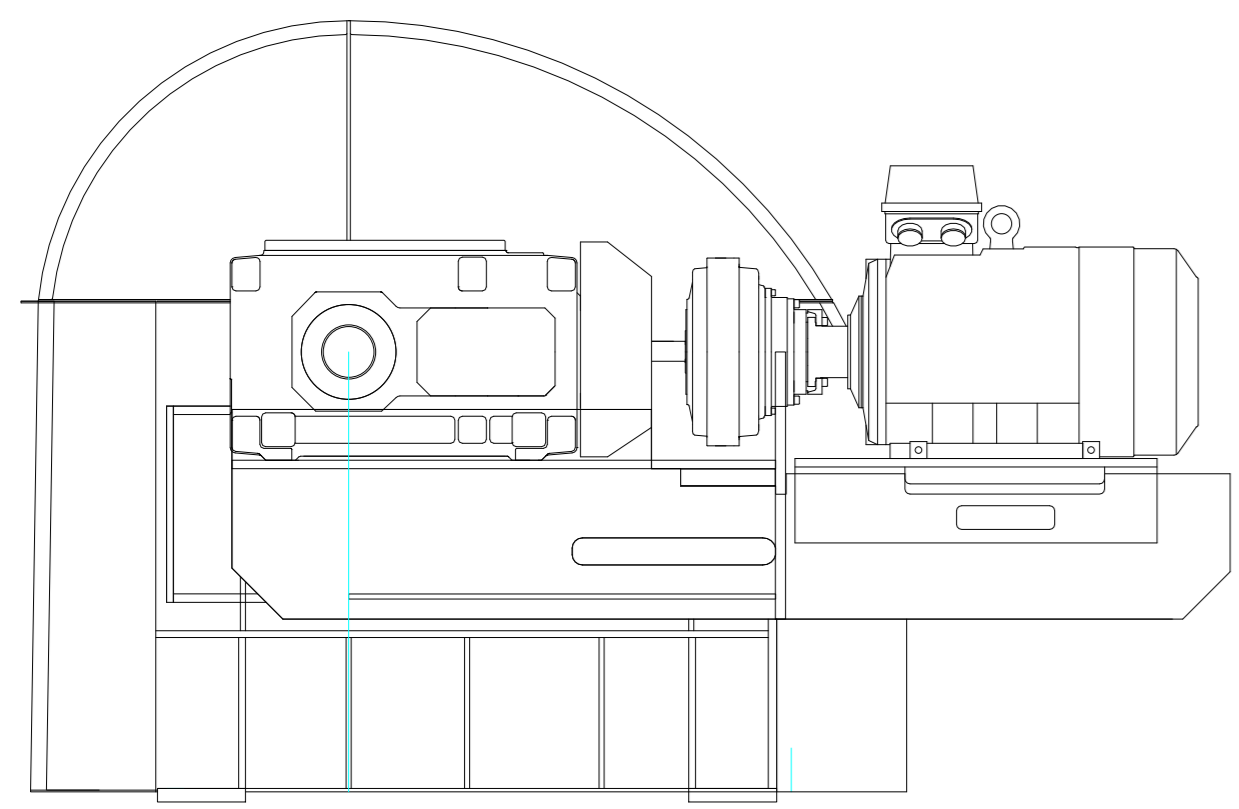

ID block: ETM1200\_DH1\_2011

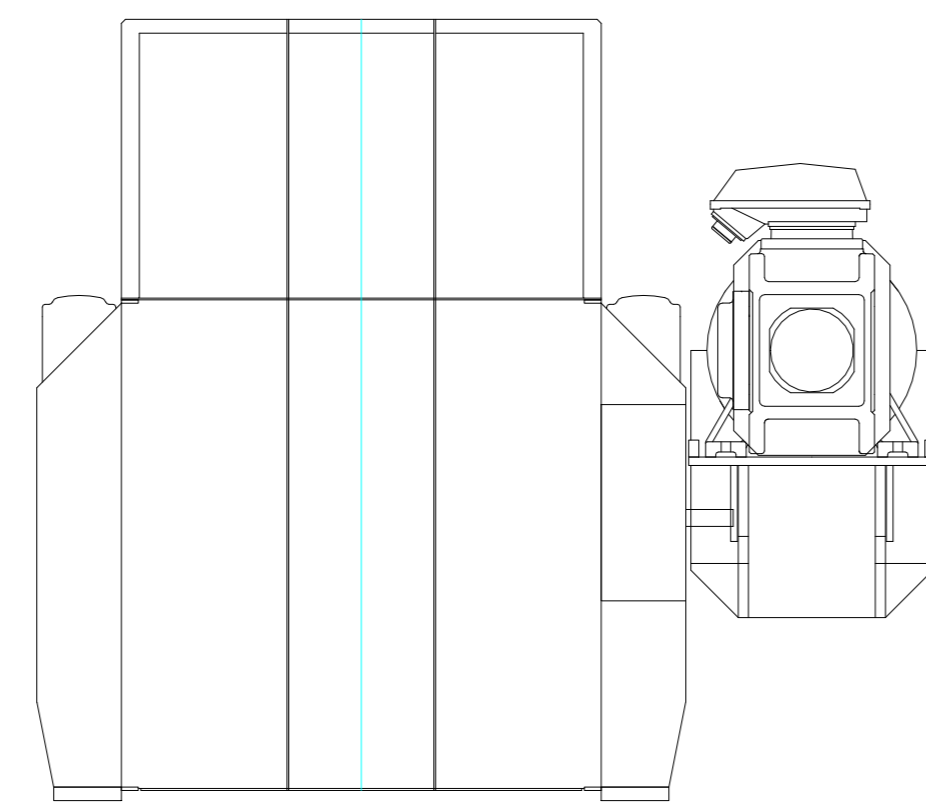

ID block: ETM1200\_DH2\_2011

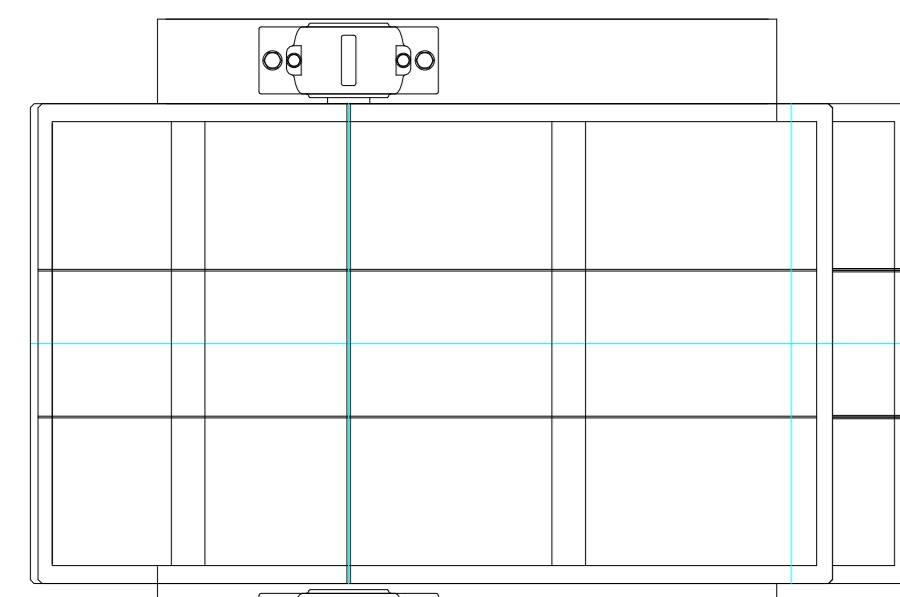

ID block: ETM1200\_DH4\_2011

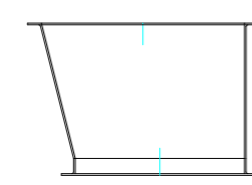

ID block: ETM1200\_SH1\_2012

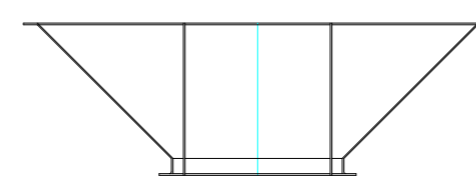

ID block: ETM1200\_SH2\_2012

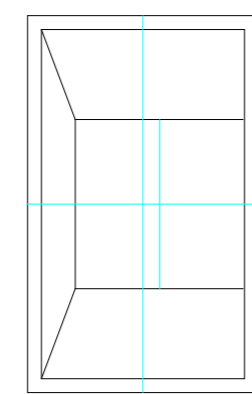

ID block: ETM1200\_SH3\_2012

WEIGHT
PESO
[kg]
7245

## PIEDE TAIL

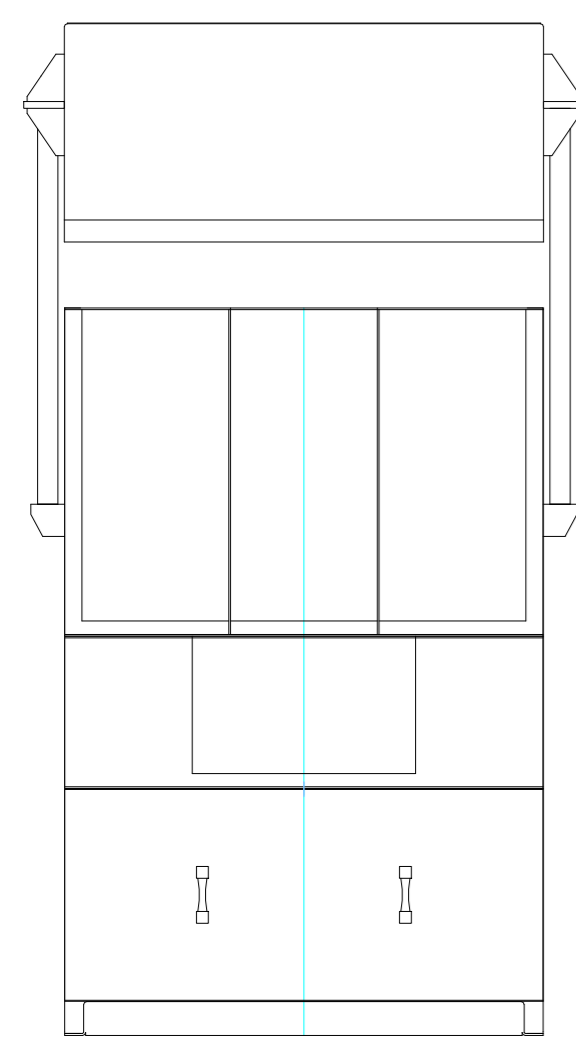

ID block: ETM1200\_F3\_2012

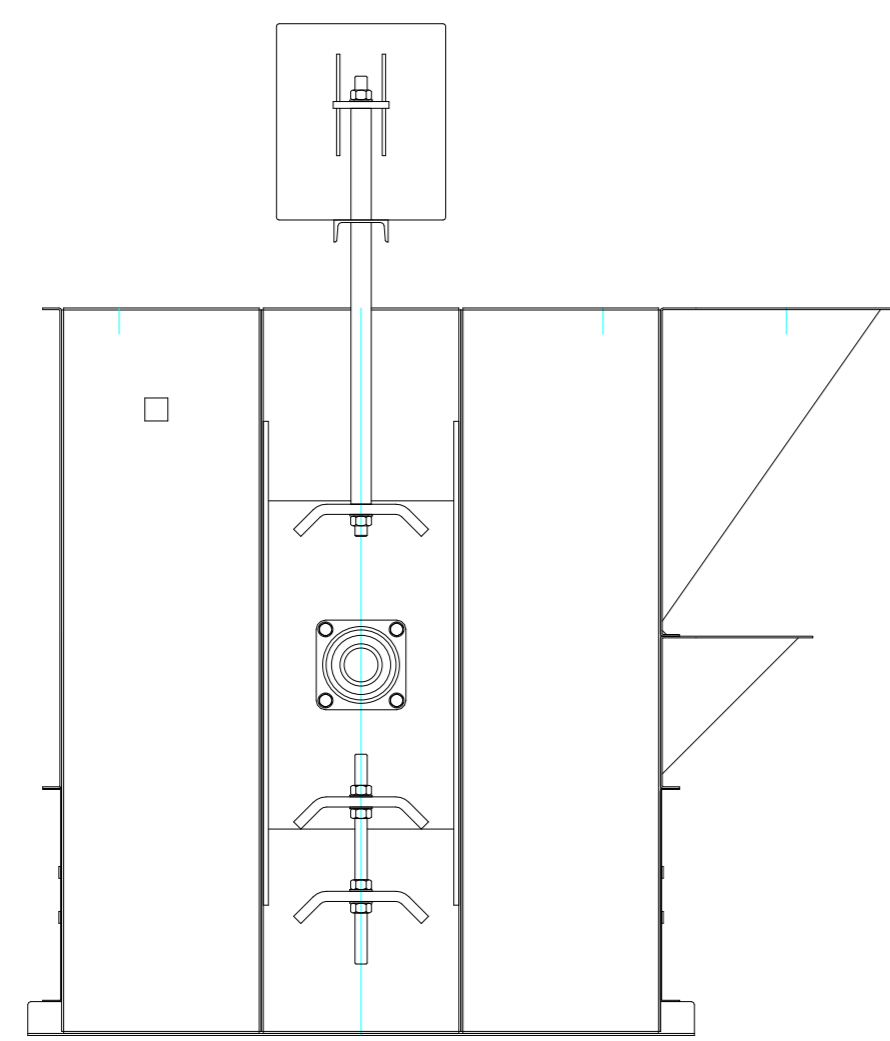

ID block: ETM1200\_F1\_2011

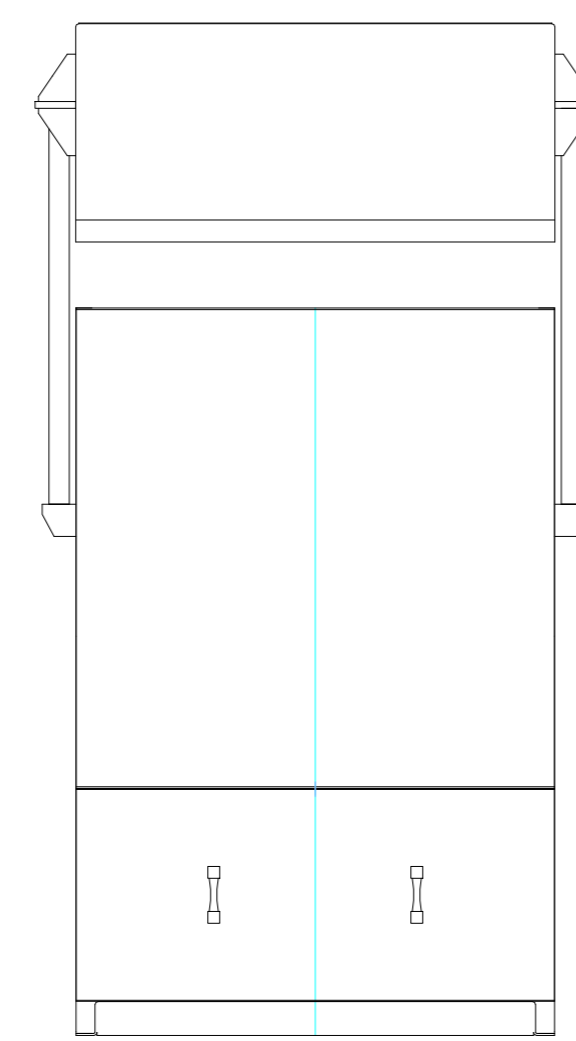

ID block: ETM1200\_F2\_2011

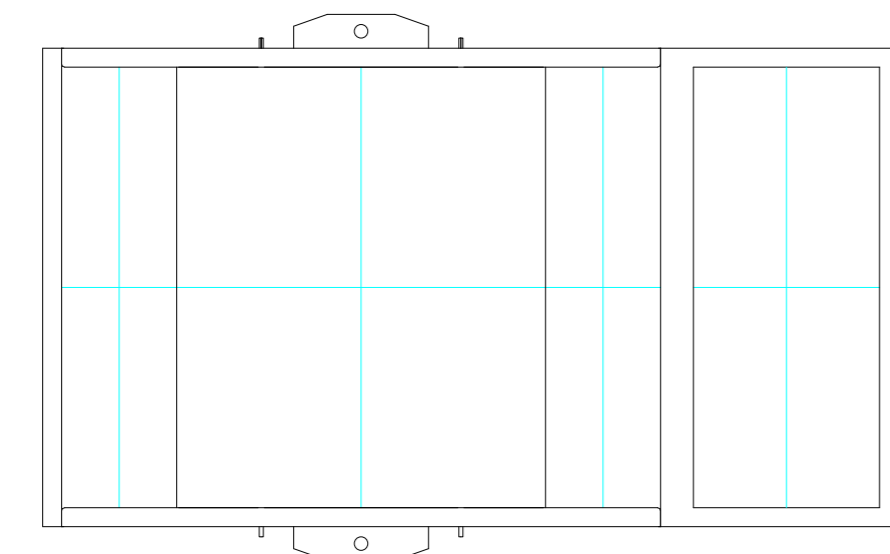

ID block: ETM1200\_F4\_2011

WEIGHT
PESO
[kg]
2500

## CANNE STANDARD STANDARD LEGS

L=2900

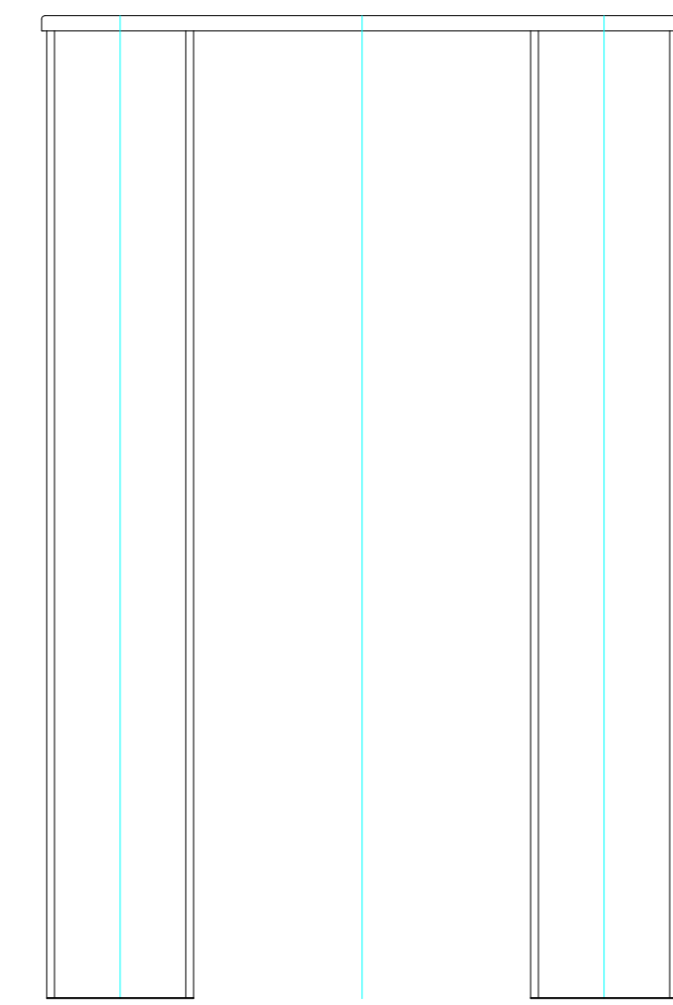

ID block: ETM1200\_SD4\_2011

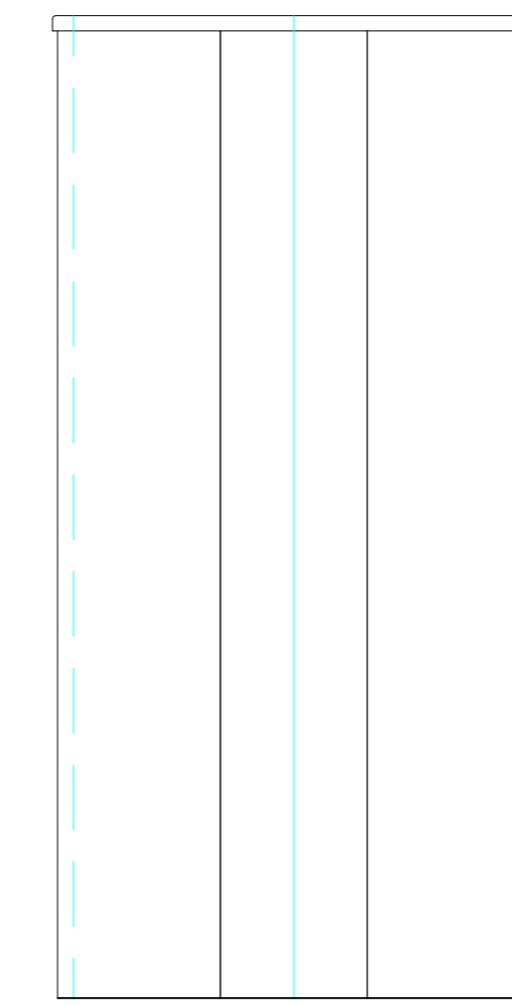

ID block: ETM1200\_SD5\_2011

WEIGHT
PESO
[kg]
555

L=2400

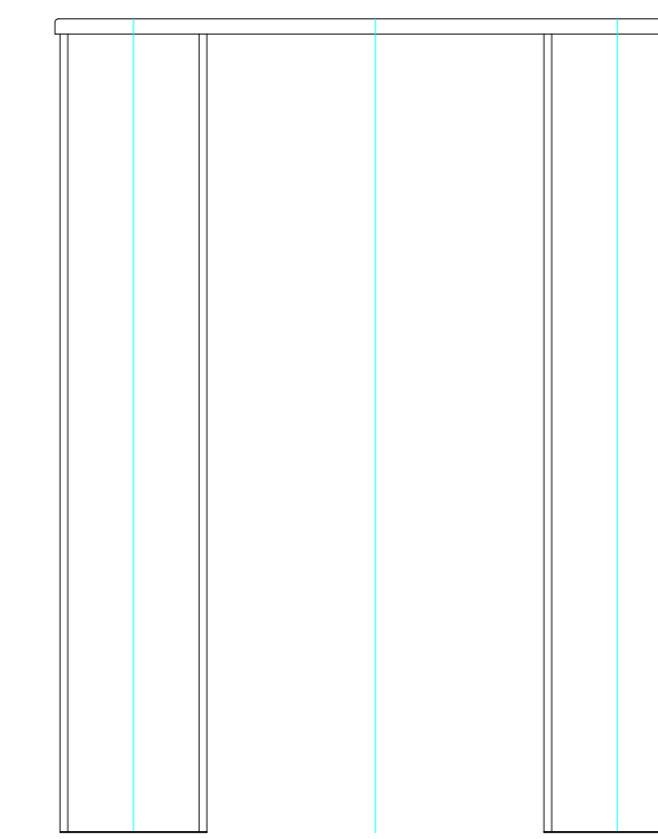

ID block: ETM1200\_SD6\_2011

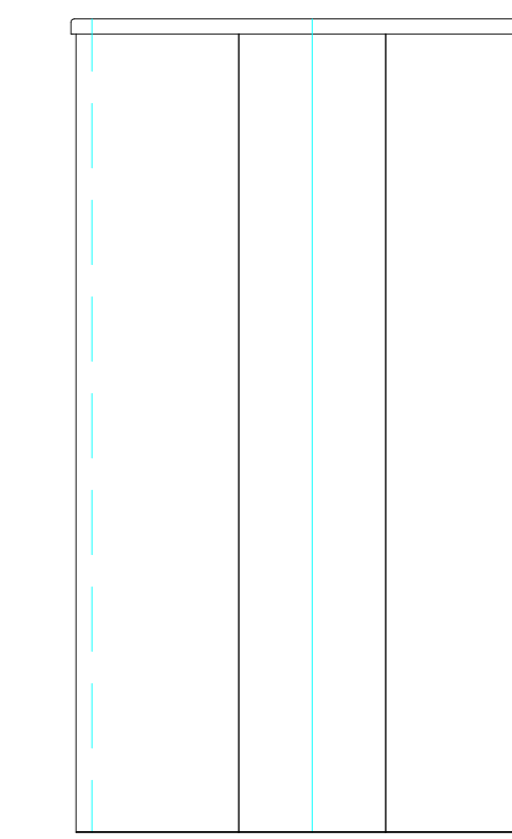

ID block: ETM1200\_SD7\_2011

L=1900

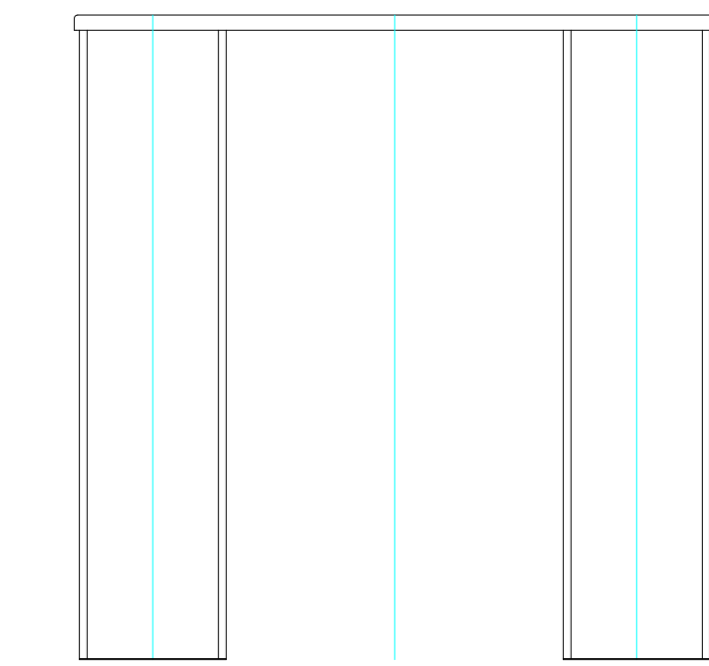

ID block: ETM1200\_SD14\_2012

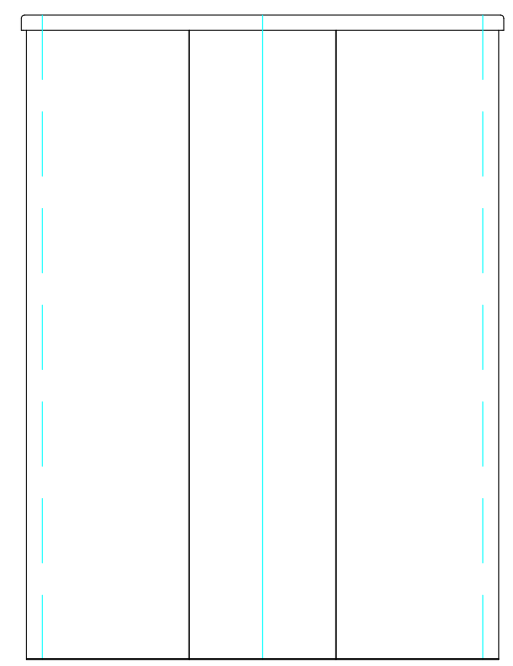

ID block: ETM1200\_SD15\_2012

L=1400

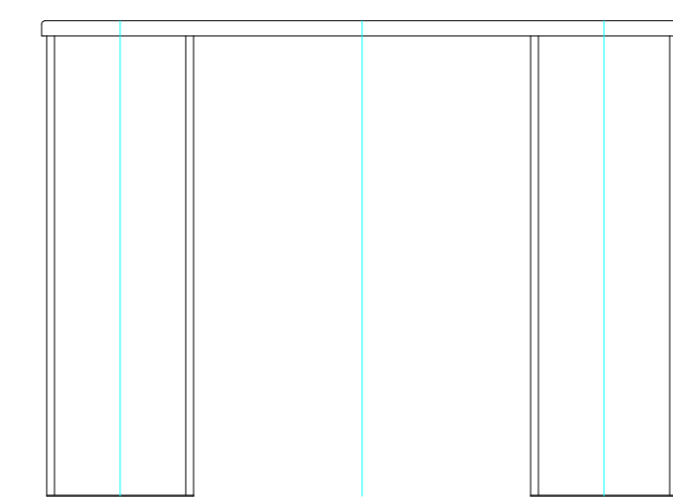

ID block: ETM1200\_SD8\_2011

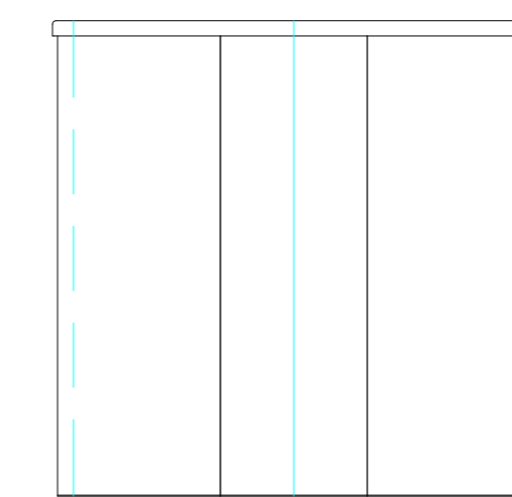

ID block: ETM1200\_SD9\_2011

L=900

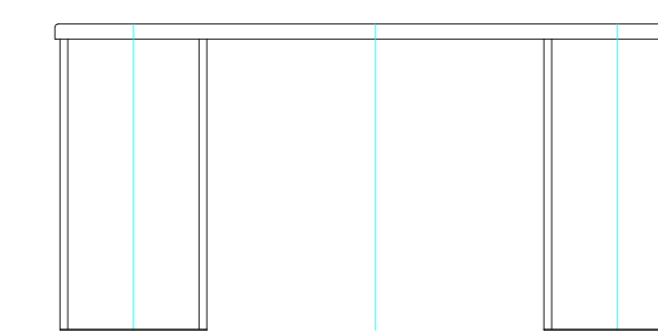

ID block: ETM1200\_SD10\_2011

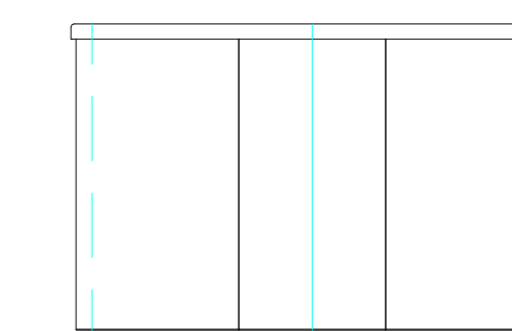

ID block: ETM1200\_SD11\_2011

L=400

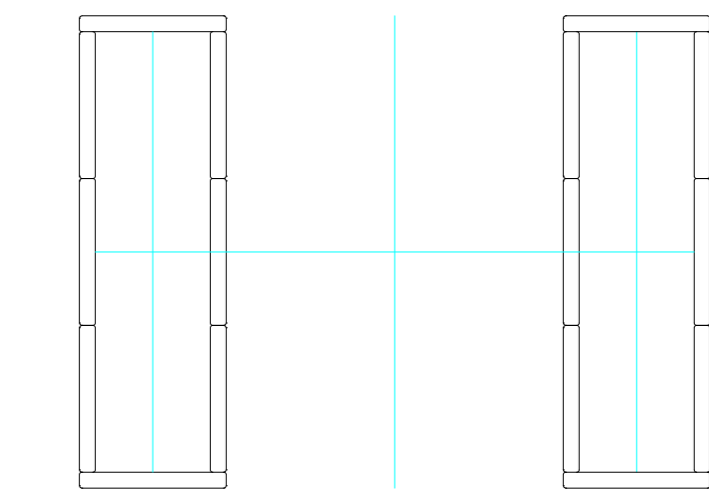

ID block: ETM1200\_SD1\_2011

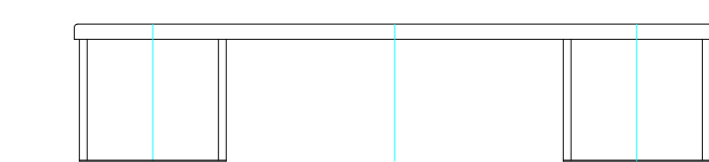

ID block: ETM1200\_SD12\_2011



ID block: ETM1200\_SD13\_2011

## CANNA D'ISPEZIONE INSPECTION LEG

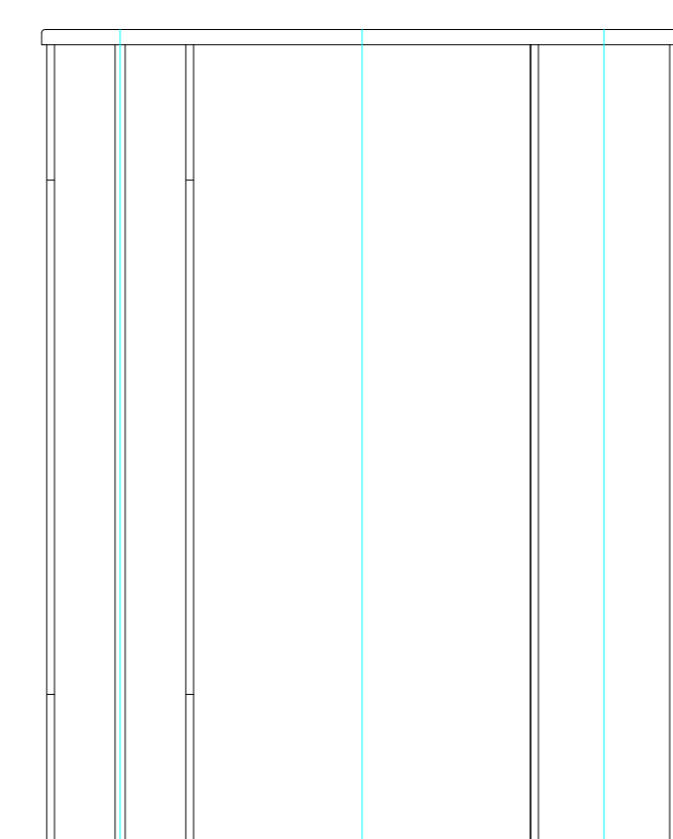

ID block: ETM1200\_ID1\_2011

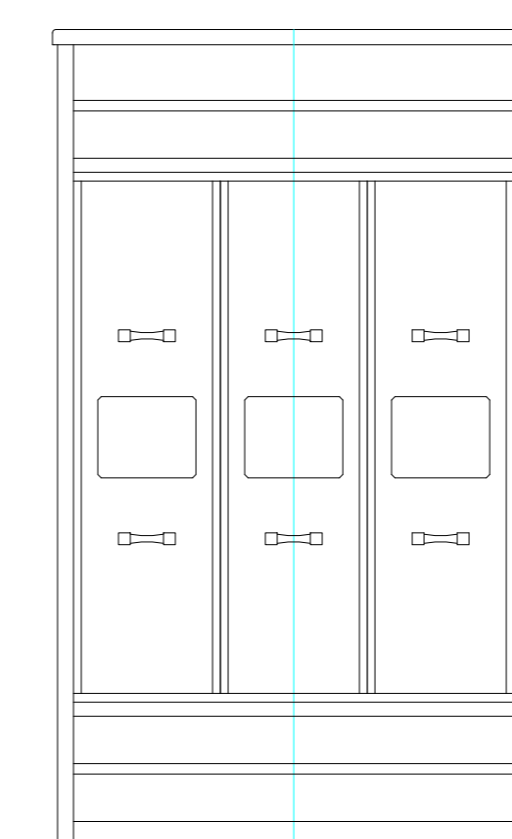

ID block: ETM1200\_ID2\_2011

## DISTANZIALE CANNE SPACER BETWEEN LEGS



ID block: ETM1200\_DL\_2012



ID block: ETM1200\_DF\_2012

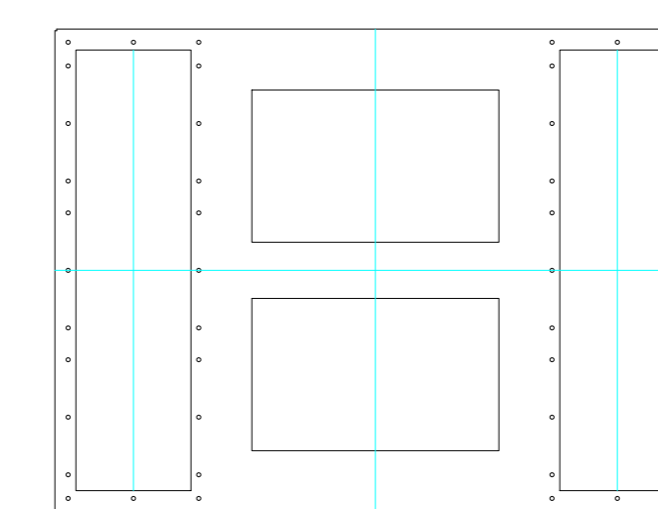

ID block: ETM1200\_DS\_2012

## CANNA D'ASPIRAZIONE L=1200, Ø250 ASPIRATION LEG L=1200, Ø250

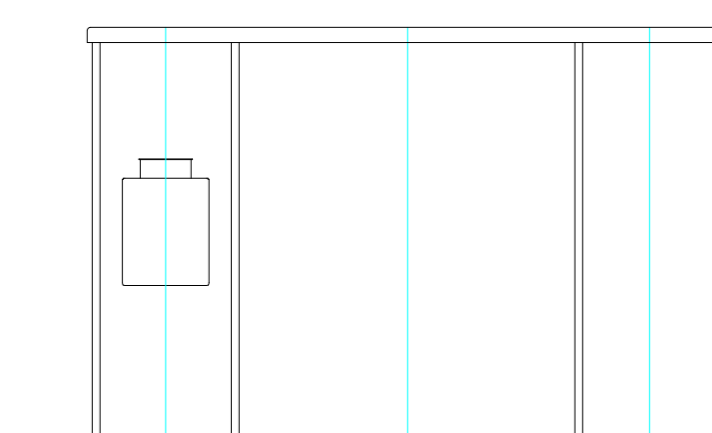

ID block: ETM1200\_AD1\_2012

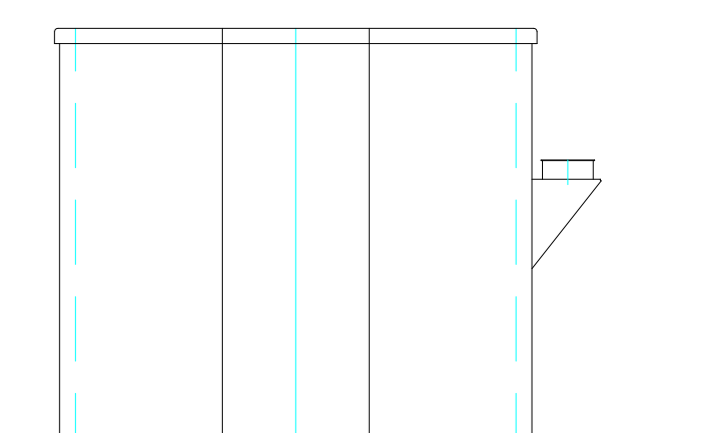

ID block: ETM1200\_AD2\_2012

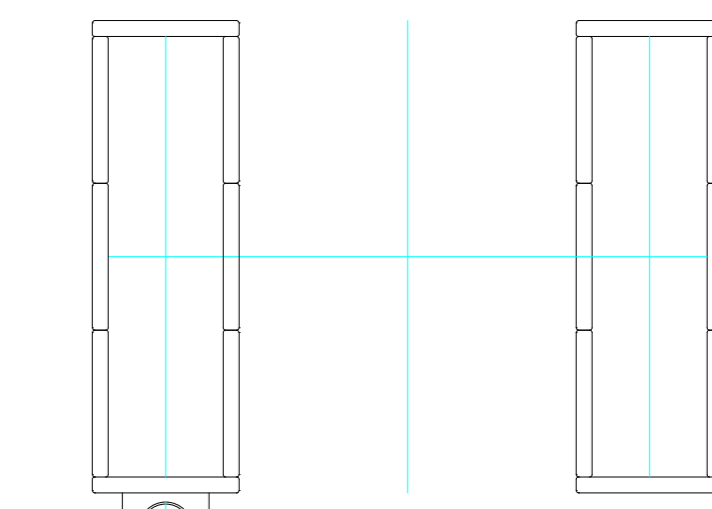

ID block: ETM1200\_AD3\_2012

of Rev.	0	EMMISSIONE / EMISSION	Descrizione modifiche:	Eseguito da:	U.T. P.T.M.	Data Approvazione:	01/12
Stato	1:1	Objekt	NORMALI TECNICI ELEVATORE A TAZZE	Data		01/01/2012	
Scale			SERIE ETM 1200 TECHNICAL DRAWING BUCKET ELEVATOR TYPE ETM 1200				

