

# ELA 470

## TESTATA DI COMANDO DRIVING HEAD

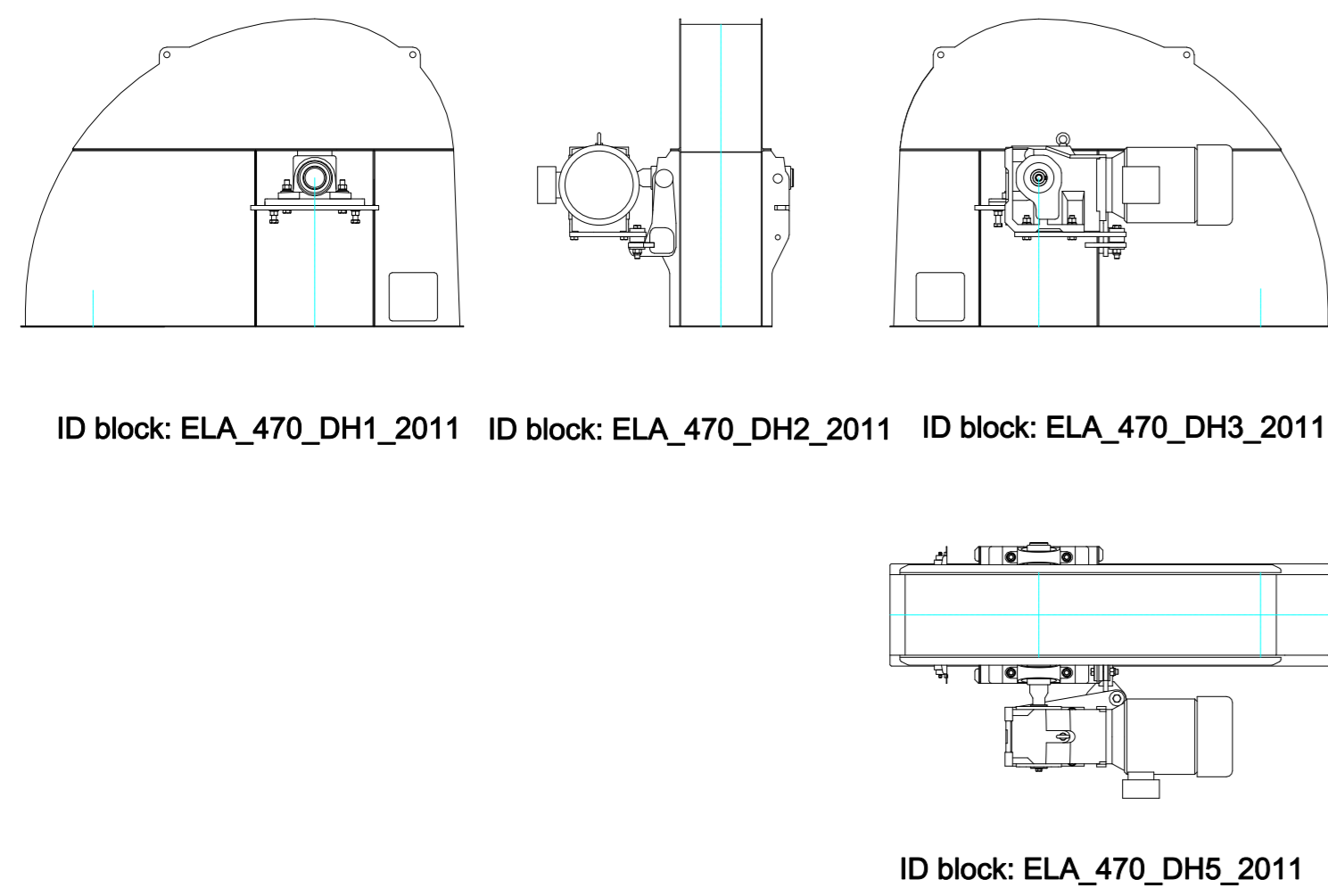

ID block: ELA\_470\_DH1\_2011 ID block: ELA\_470\_DH2\_2011 ID block: ELA\_470\_DH3\_2011

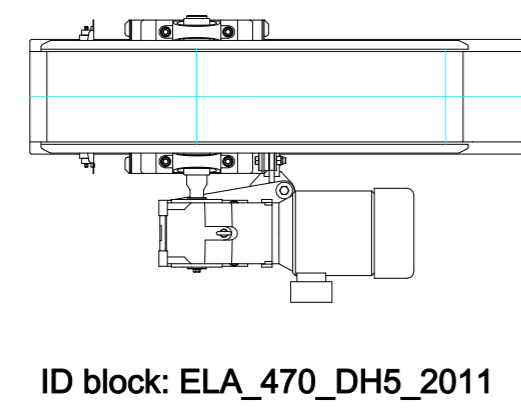

ID block: ELA\_470\_DH5\_2011

WEIGHT
PESO
[kg]
522

## CANNE STANDARD STANDARD LEGS

L=2900

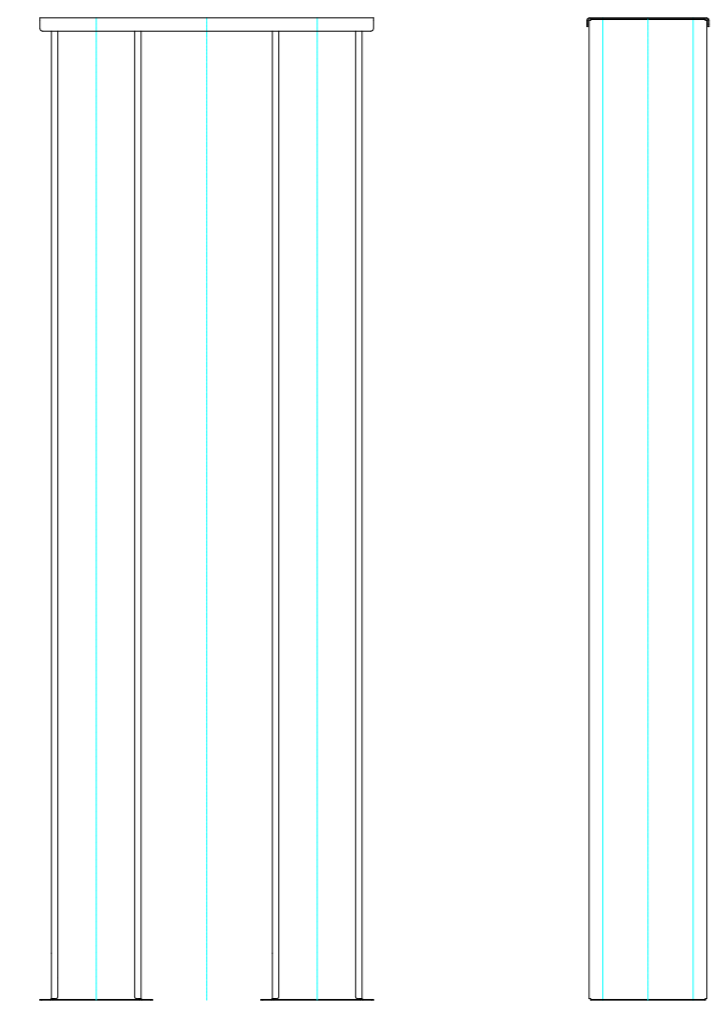

ID block: ELA\_470\_SD2900F\_2012 ID block: ELA\_470\_SD2900L\_2012

WEIGHT
PESO
[kg/m]
90

L=2400

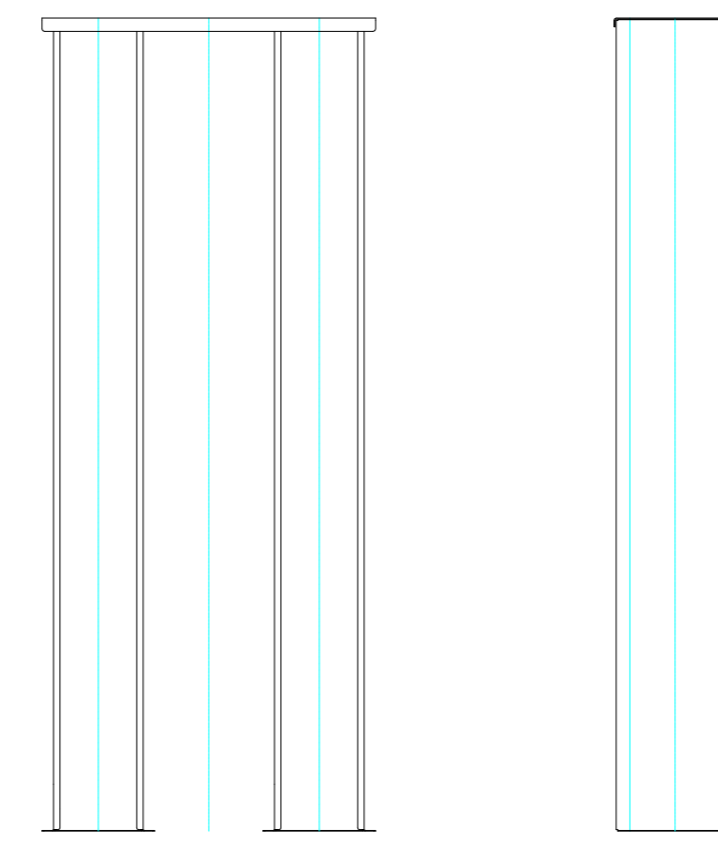

ID block: ELA\_470\_SD2400F\_2011 ID block: ELA\_470\_SD2400L\_2011

L=1900

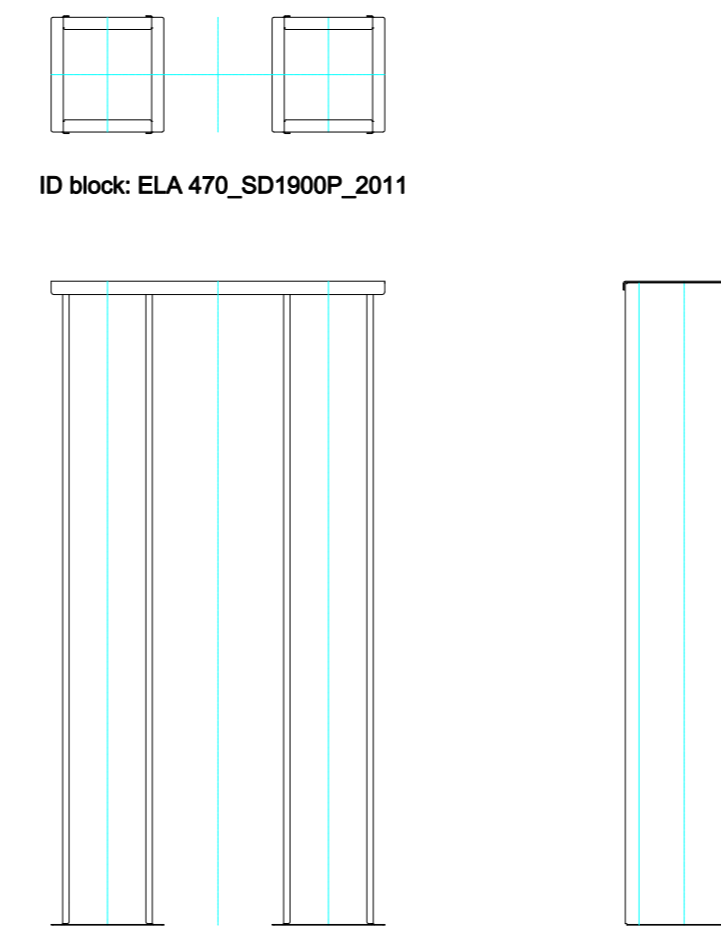

ID block: ELA\_470\_SD1900P\_2011

ID block: ELA\_470\_SD1900F\_2011 ID block: ELA\_470\_SD1900L\_2011

L=1400

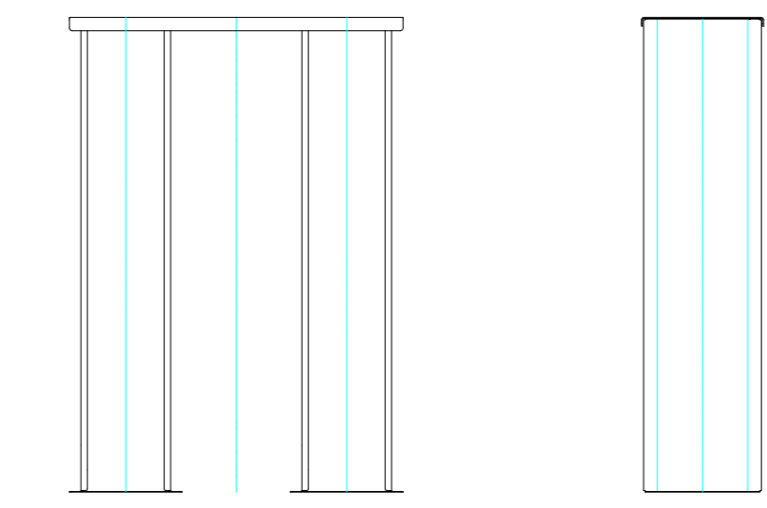

ID block: ELA\_470\_SD1400F\_2011 ID block: ELA\_470\_SD1400L\_2011

L=900

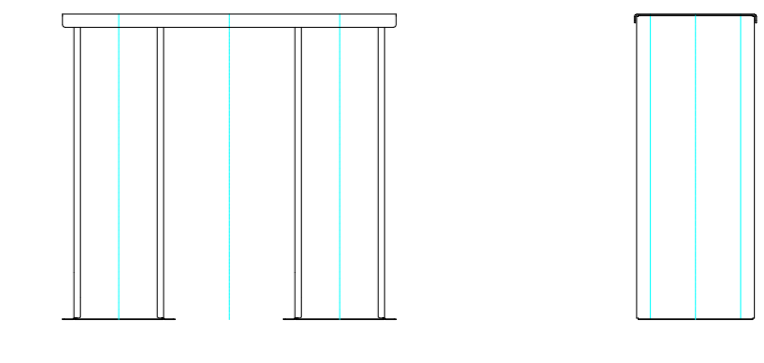

ID block: ELA\_470\_SD900F\_2011 ID block: ELA\_470\_SD900L\_2011

L=400

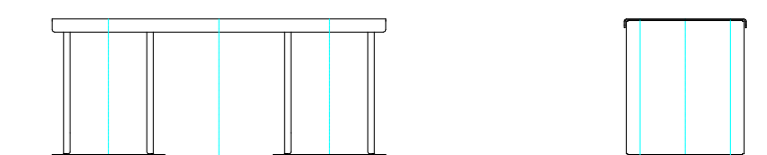

ID block: ELA\_470\_SD400F\_2011 ID block: ELA\_470\_SD400L\_2011

## PIEDE TAIL

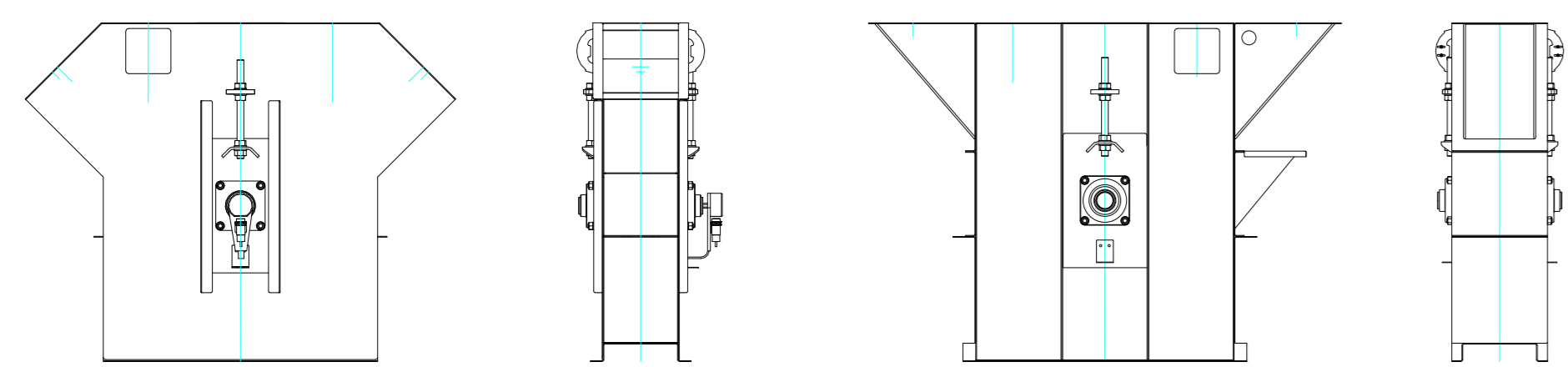

ID block: ELA\_470\_TF\_2011 ID block: ELA\_470\_TL\_2011 ID block: ELA\_470\_TF\_2012 ID block: ELA\_470\_TL\_2012

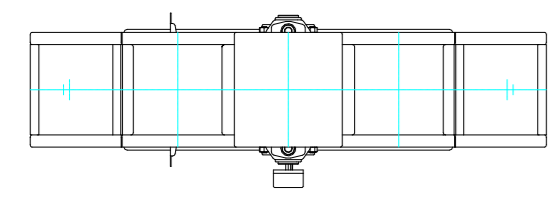

ID block: ELA\_470\_DHS\_2011

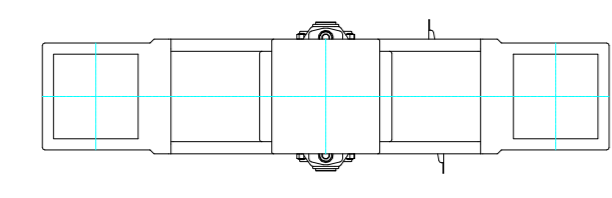

ID block: ELA\_470\_DHS\_2012

WEIGHT
PESO
[kg]
200

## DISTANZIALE SPECIALE CON ANCORAGGIO SPECIAL SPACER WITH ANCHORAGE

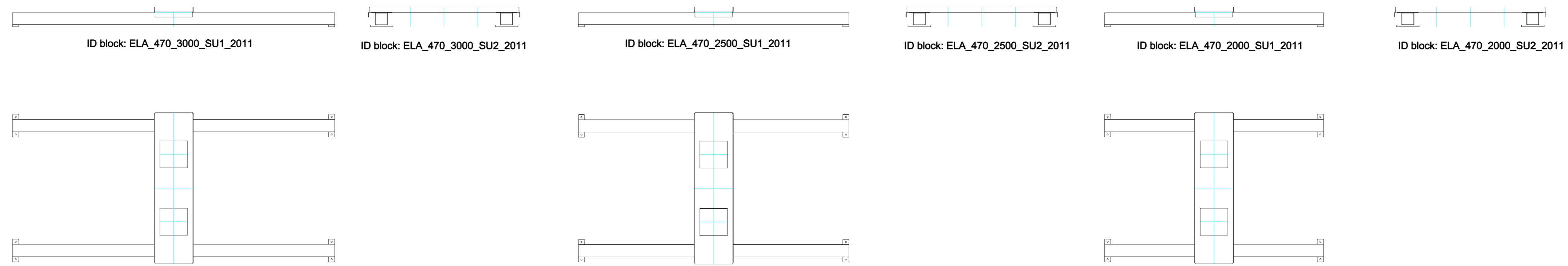

ID block: ELA\_470\_3000\_SU1\_2011

ID block: ELA\_470\_3000\_SU2\_2011

ID block: ELA\_470\_2500\_SU1\_2011

ID block: ELA\_470\_2500\_SU2\_2011

ID block: ELA\_470\_2000\_SU1\_2011

ID block: ELA\_470\_2000\_SU2\_2011

ID block: ELA\_470\_3000\_SU3\_2011

ID block: ELA\_470\_2500\_SU3\_2011

ID block: ELA\_470\_2000\_SU3\_2011

## DISTANZIALE CANNE SPACER BETWEEN LEGS

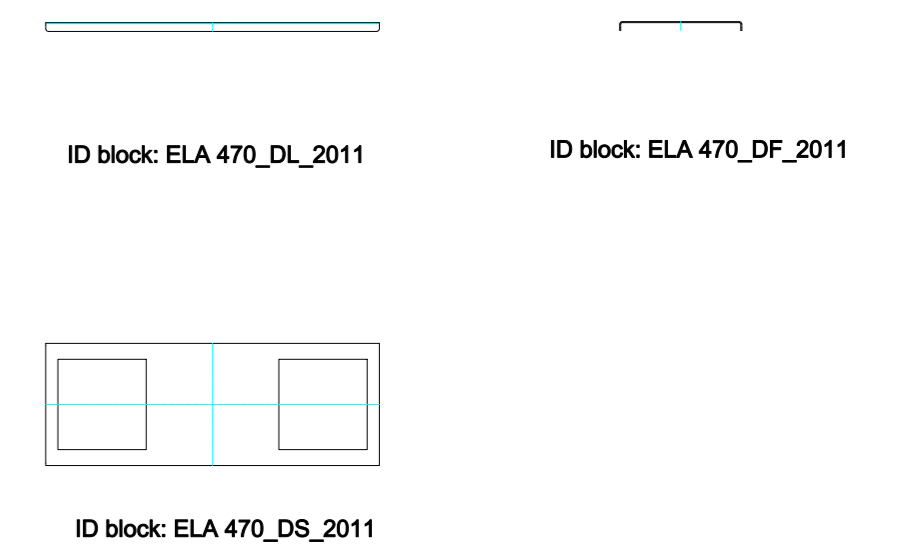

ID block: ELA\_470\_DL\_2011

ID block: ELA\_470\_DF\_2011

ID block: ELA\_470\_DS\_2011

## CANNA D'ISPEZIONE INSPECTION LEG

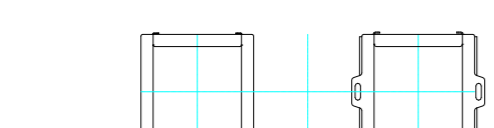

ID block: ELA\_470\_ID1400P\_2011

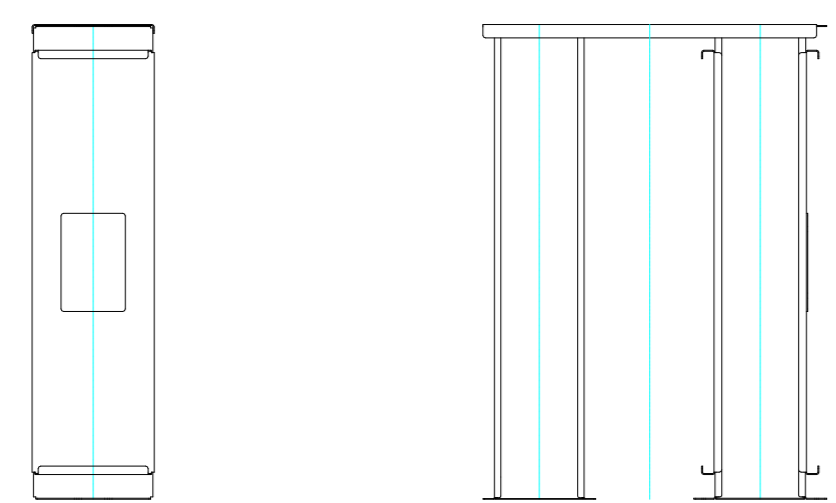

ID block: ELA\_470\_ID1400L\_2011

ID block: ELA\_470\_ID1400F\_2011

## TRAMOGGIA DI SCARICO 250x250 OUTLET HOPPER 250x250

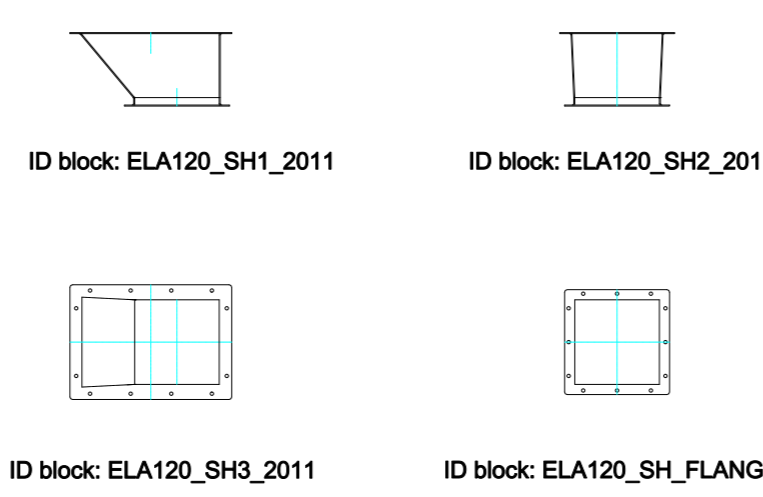

ID block: ELA120\_SH1\_2011

ID block: ELA120\_SH2\_2011

ID block: ELA120\_SH3\_2011

ID block: ELA120\_SH\_FLANGE\_2011

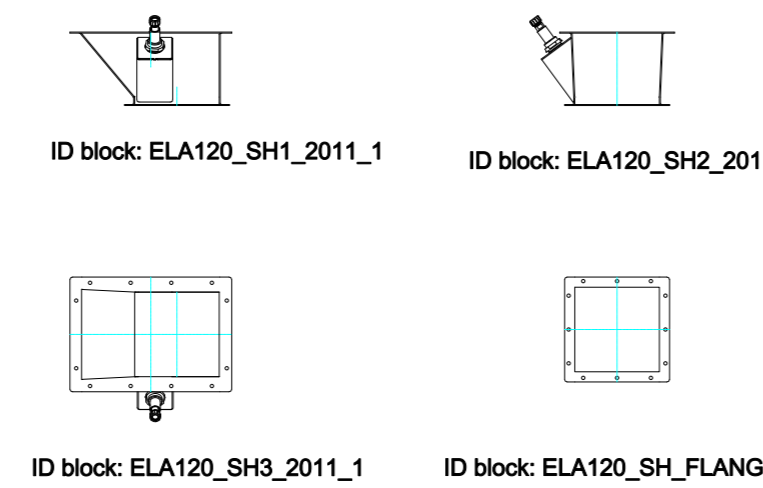

ID block: ELA120\_SH1\_2011\_1

ID block: ELA120\_SH2\_2011\_1

ID block: ELA120\_SH3\_2011\_1

ID block: ELA120\_SH\_FLANGE\_2011\_1

## TRAMOGGIA DI SCARICO 200x200 OUTLET HOPPER 200x200

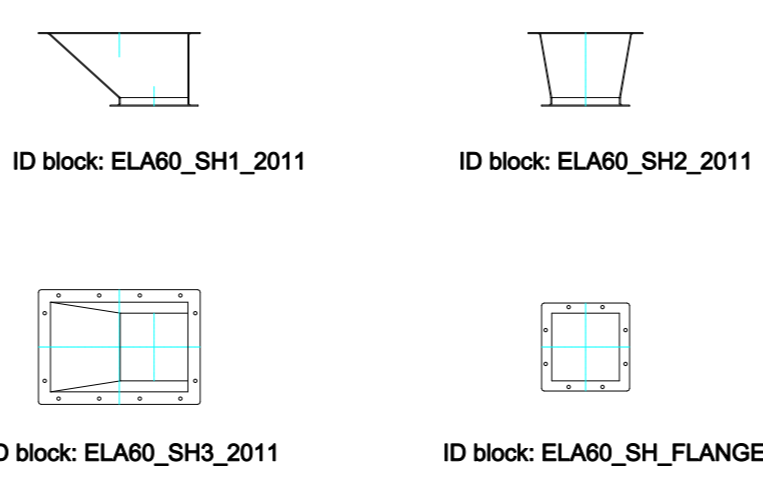

ID block: ELA60\_SH1\_2011

ID block: ELA60\_SH2\_2011

ID block: ELA60\_SH3\_2011

ID block: ELA60\_SH\_FLANGE\_2011

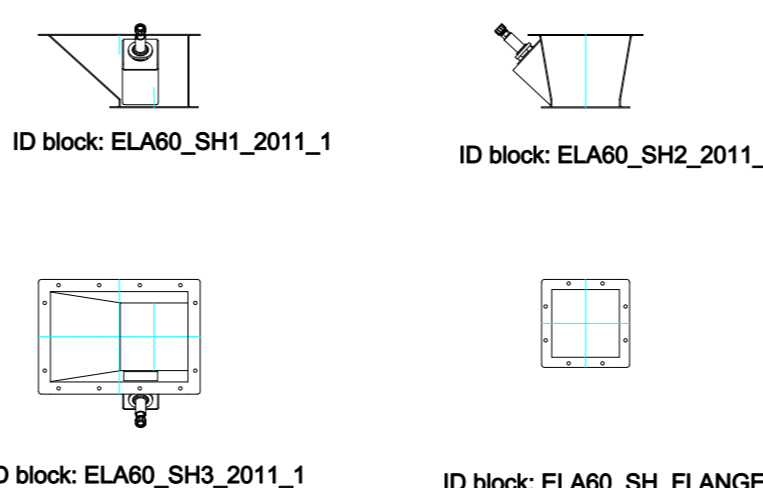

ID block: ELA60\_SH1\_2011\_1

ID block: ELA60\_SH2\_2011\_1

ID block: ELA60\_SH3\_2011\_1

ID block: ELA60\_SH\_FLANGE\_2011\_1

## TRAMOGGIA DI ALIM. 250x250 INLET HOPPER 250x250

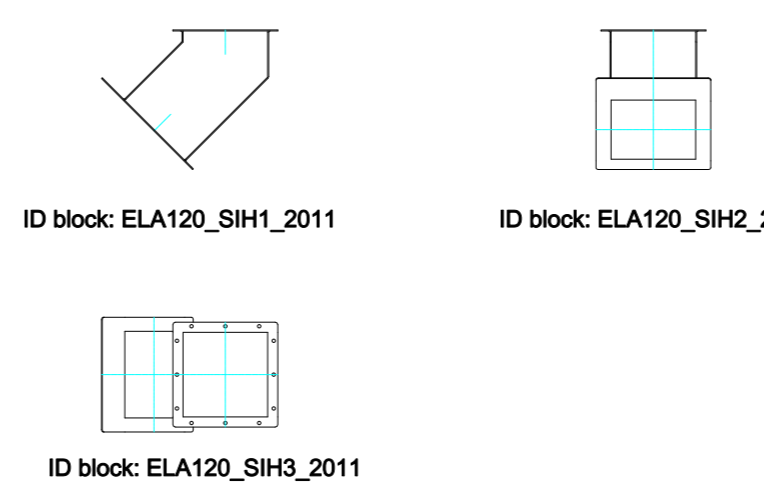

ID block: ELA120\_SH1\_2011

ID block: ELA120\_SH2\_2011

ID block: ELA120\_SH3\_2011

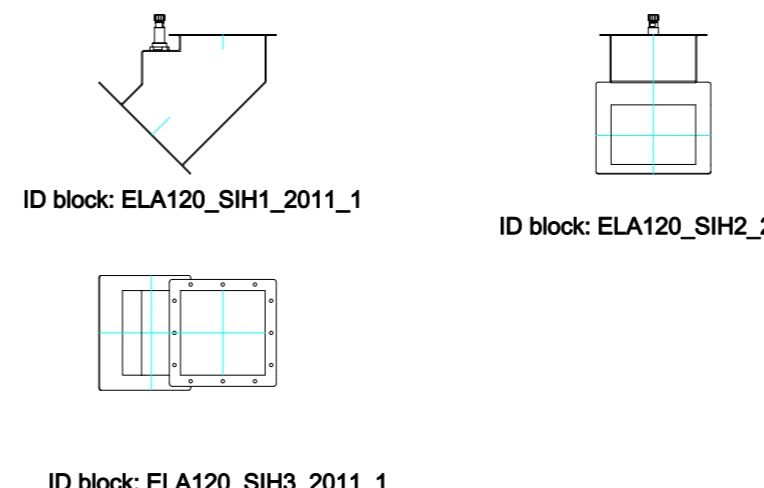

ID block: ELA120\_SH1\_2011\_1

ID block: ELA120\_SH2\_2011\_1

ID block: ELA120\_SH3\_2011\_1

## TRAMOGGIA DI ALIM. 200x200 INLET HOPPER 200x200

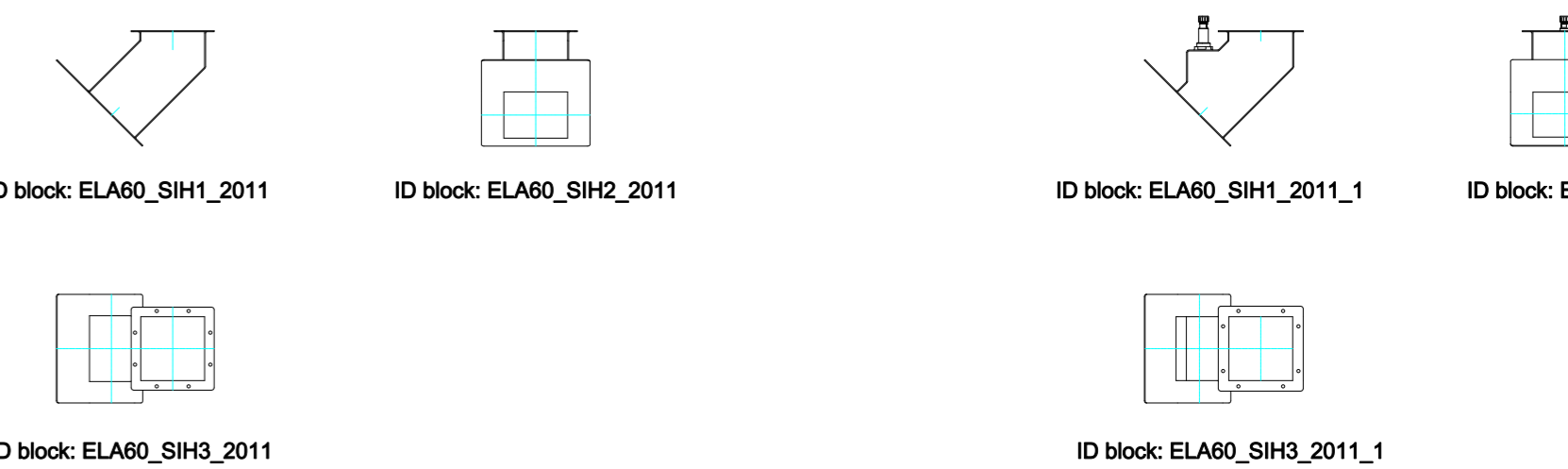

ID block: ELA60\_SH1\_2011

ID block: ELA60\_SH2\_2011

ID block: ELA60\_SH3\_2011

ID block: ELA60\_SH1\_2011\_1

ID block: ELA60\_SH2\_2011\_1

ID block: ELA60\_SH3\_2011\_1

0	EMMISSIONE / EMISSION	Descrizione modifica:	Eseguito da:	Data Approvazione:
Scale	1:1	Object	NORMALINI TECNICI	01/12
SERIE ELA 470		TECHNICAL DRAWING		
BUCKET ELEVATOR		TYPE ELA 470		
PTA PRODUZIONE TECNOLOGIE AVANZATE S.p.A. 39065 ESTE (PD) ITALY Via Mare Trionfale, 10 Tel. +39 0429 801000 Fax +39 0429 801001 Email: info@ptainnovology.com				

